

WATTNODE[®] MODBUS

Installation and Operation Manual



WattNode Modbus Models

- WNC-3Y-208-MB
- WNC-3Y-400-MB
- WNC-3Y-480-MB
- WNC-3Y-600-MB
- WNC-3D-240-MB
- WNC-3D-400-MB
- WNC-3D-480-MB

WattNode Revenue for Modbus Models

- RWNC-3Y-208-MB
- RWNC-3Y-400-MB
- RWNC-3Y-480-MB
- RWNC-3Y-600-MB
- RWNC-3D-240-MB
- RWNC-3D-400-MB
- RWNC-3D-480-MB

Information in this document is subject to change without notice.

©2007-2015 Continental Control Systems, LLC. All rights reserved.

Document Number: WNC-MB-1.18c

Firmware Versions: 18-24

Revision Date: November 3, 2015

Continental Control Systems, LLC.

3131 Indian Rd.

Boulder, CO 80301, U.S.A.

+1 (303) 444-7422

FAX: +1 (303) 444-2903

E-mail: techsupport@ccontrolsys.com

Web: <http://www.ccontrolsys.com>

WattNode is a registered trademark of Continental Control Systems, LLC.

FCC Information

This equipment has been tested and complies with the limits for a Class B digital device, pursuant to part 15 of the FCC Rules. Operation is subject to the following two conditions: (1) This device may not cause harmful interference, and (2) this device must accept any interference received, including interference that may cause undesired operation.

The FCC limits are designed to provide reasonable protection against harmful interference in a residential installation. This equipment generates, uses and can radiate radio frequency energy and, if not installed and used in accordance with the instructions, may cause harmful interference to radio communications. However, there is no guarantee that interference will not occur in a particular installation. If this equipment does cause harmful interference to radio or television reception, which can be determined by turning the equipment off and on, the user is encouraged to try to correct the interference by one or more of the following measures:

- Reorient or relocate the receiving antenna.
- Increase the separation between the equipment and receiver.
- Connect the equipment into an outlet on a circuit different from that to which the receiver is connected.
- Consult the dealer or an experienced radio/TV technician to help.

Contents

Overview	5
Measurements	5
Communication	5
Diagnostic LEDs	5
Options	5
Current Transformers.....	6
Additional Literature.....	6
Front Label.....	7
Installation	9
Precautions	9
Electrical Service Types.....	10
Single-Phase Two-Wire with Neutral.....	10
Single-Phase Three-Wire (Mid-Point Neutral)	11
Single-Phase Two-Wire without Neutral	12
Three-Phase Four-Wire Wye.....	13
Three-Phase Three-Wire Delta Without Neutral.....	14
Three-Phase Four-Wire Delta (Wild Leg)	14
Grounded Leg Service	14
Mounting.....	15
Selecting Current Transformers	16
Connecting Current Transformers	17
Circuit Protection.....	18
Connecting Voltage Terminals.....	19
Setting the Modbus Address	19
Baud Rate.....	20
Connecting Modbus Outputs.....	20
Planning the Modbus Network	20
Installation Summary	22
Wiring	22
Installation LED Diagnostics.....	23
Other Fixed Pattern	25
Measurement Troubleshooting.....	25
Modbus Communication Diagnostics	28
Operating Instructions.....	30
Quick Start.....	30
WattNode Basic Configuration	30
Verify Operation	30
Measurement Overview.....	31
Modbus Communication	31
Modbus Functions	31
Modbus Register Lists.....	32
Modbus Register Addressing	32
Report Slave ID.....	32
Floating Point and Integer Registers	33
Reading and Writing 32 Bit Registers	33
Basic Register List - Floating Point	34
Basic Register List - Integer.....	34
Advanced Register List - Floating Point	35

Advanced Register List - Integer.....	36
Configuration Register List	37
Communication Register List.....	38
Diagnostic Register List.....	38
Option Information Registers	39
Custom Register Map	39
Basic Registers	40
Energy Registers	40
Power Registers	40
Voltage Registers	41
Frequency	41
Advanced Registers	41
Per-Phase Energy Registers	41
Positive Energy.....	41
Negative Energy	42
Reactive Energy	42
Apparent Energy	42
Power Factor.....	42
Reactive Power	43
Apparent Power	43
Current.....	44
Demand	44
I/O Pin Options.....	46
Configuration Registers	46
Demand Configuration	48
Zeroing Registers	49
I/O Pin Options Configuration	50
Communication Registers.....	50
Diagnostic Registers.....	51
Error Codes.....	52
Maintenance and Repair.....	54
Specifications	55
Models	55
Model Options	55
Accuracy.....	56
Measurement	57
Modbus Communication	57
Electrical	58
Certifications	59
Environmental.....	59
Mechanical.....	59
Current Transformers.....	59
Warranty.....	60
Limitation of Liability	60

Overview

Congratulations on your purchase of the WattNode® Modbus® watt/watt-hour transducer (meter). The WattNode meter offers precision energy and power measurements in a compact package. It enables you to make power and energy measurements within existing electric service panels avoiding the costly installation of subpanels and associated wiring. It is designed for use in demand side management (DSM), sub-metering, and energy monitoring applications. The WattNode meter communicates on an EIA RS-485 two-wire bus using the Modbus protocol. Models are available for single-phase, three-phase wye, and three-phase delta configurations for voltages from 120 VAC to 600 VAC at 50 and 60 Hz.

Measurements

The WattNode Modbus meter measures the following:

- True RMS Power - Watts (Phase A, Phase B, Phase C, Sum)
- Reactive Power - VARs (Phase A, Phase B, Phase C, Sum)
- Power Factor (Phase A, Phase B, Phase C, Average)
- True RMS Energy - Watthours (Phase A, Phase B, Phase C, Sum)
- Reactive Energy - VAR-hours (Sum)
- AC Frequency
- RMS Voltage (Phase A, Phase B, Phase C)
- RMS Current (Phase A, Phase B, Phase C)
- Demand and Peak Demand

One WattNode Modbus meter can measure up to three different “single-phase two-wire with neutral” branch circuits from the same service by separately monitoring the phase A, B, and C values. If necessary, you can use different CTs on the different circuits.

Communication

The WattNode meter uses a half-duplex EIA RS-485 interface for communication. The standard baud rates are 9,600 and 19,200 baud, and rates from 1,200 to 38,400 baud can be configured. The meter uses the industry standard Modbus RTU (binary) communication protocol, allowing up to 127 devices per RS-485 subnet. The WattNode meter can auto-detect RS-485 polarity on properly biased networks, simplifying installation.

There are numerous low-cost RS-485 interfaces to PCs, using both USB and serial ports. There are many PC programs and standalone devices for collecting and recording Modbus data.

Diagnostic LEDs

The meter includes three power diagnostic LEDs—one per phase. During normal operation, these LEDs flash on and off, with the speed of flashing roughly proportional to the power on each phase. The LEDs flash green for positive power and red for negative power. Other conditions are signaled with different LED patterns. See [Installation LED Diagnostics \(p. 23\)](#) for details.

The Modbus WattNode meter includes a communication LED that lights green, yellow, or red to diagnose the RS-485 network. See [Modbus Communication Diagnostics \(p. 28\)](#) for details.

Options

The WattNode Modbus meter can be ordered with several options. For more details and documentation, see article [WattNode Modbus - Options](#) on our website.

General Options

- *Option CT=xxx* - Pre-assign xxx as the global **CtAmps** value.

- **Option CT=xxx/yyy/zzz** - Pre-assign xxx to **CtAmpsA**, yyy to **CtAmpsB**, and zzz to **CtAmpsC**.

Communication Options

- **Option EP** - Factory configure the Modbus RS-485 communications to even parity (E81).
- **Option 19K** - Factory configure the RS-485 communications 19,200 baud. Position 8 of the DIP switch will be ignored.
- **Option 38K** - Factory configure the RS-485 communications to 38,400 baud. Position 8 of the DIP switch will be ignored.
- **Option TCP-RTU** - Configure the communications to the Modbus TCP-RTU protocol option for use with RS-485 to Ethernet gateways (serial device adapters).
- **Option AD** - Factory configure the Modbus address. The DIP switch address will be ignored.

X Terminal Options

These options utilize the **X** (auxiliary) terminal on the **MODBUS** connector. Only one of these can be ordered on any single meter.

- **Option X5** - Provides 5 VDC at up to 60 milliamps between the **C** (common) and **X** (5 V) terminals.
- **Option IO** - Provides a digital input (level sensing and pulse counting) or output (for load shedding and other applications) on the **X** terminal.
- **Option SSR** - Provides a solid-state relay (contact closure) output between the **X** and **C** terminals for load shedding and other applications.

Special Options

Contact the factory about the following special options:

- **Option 232** - Provide RS-232 I/O in place of RS-485.
- **Option TTL** - Provide 5 V TTL UART I/O in place of RS-485.

Current Transformers

The WattNode meter uses solid-core (toroidal), split-core (opening), and bus-bar style current transformers (CTs) with a full-scale voltage output of 0.33333 Vac. Split-core and bus-bar CTs are easier to install without disconnecting the circuit being measured. Solid-core CTs are more compact, generally more accurate, and less expensive, but installation requires that you disconnect the circuit to install the CTs.

Additional Literature

These additional documents are available on the Continental Control Systems, LLC website or Modbus.org website.

- WattNode Modbus - Quick Install Guide
- WattNode Modbus Register List (Excel format): [WNC-Modbus-Register-List-V18.xls](#)
- Continental Control Systems, LLC website
 - http://www.ccontrols.com/w/WattNode_Modbus - main page.
 - http://www.ccontrols.com/w/Category:WattNode_Modbus - support articles.
- <http://www.modbus.org/specs.php>
 - Modbus Application Protocol Specification - V1.1b
 - Modbus over Serial Line - Specification & Implementation Guide - V1.0

Front Label

This section describes the connections, information, and symbols on the front label.

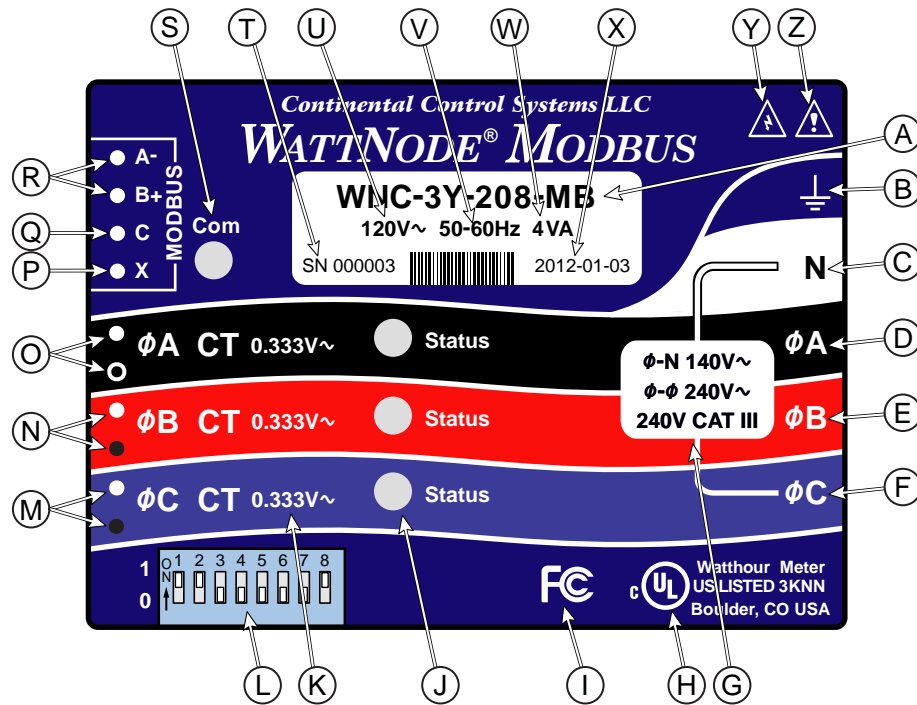

Figure 1: Front Label Diagram

- A: WattNode model number.** The “WNC” indicates a third generation WattNode meter with diagnostic LEDs. The “3” indicates a three-phase model. The “Y” or “D” indicates wye or delta models, although delta models can measure wye circuits (the difference is in the power supply). The “208” (or other value) indicates the nominal line-to-line voltage. Finally, the “MB” indicates Modbus output.
- B: Functional ground.** This terminal should be connected to earth ground if possible. It is not required for safety grounding, but ensures maximum meter accuracy.
- C: Neutral.** This terminal “N” should be connected to neutral when available.
- D, E, F: Line voltage inputs.** These terminals connect to the ϕA (phase A), ϕB (phase B), and ϕC (phase C) electric mains. On wye models the meter is powered from the ϕA and **N** terminals. On delta models, the meter is powered from the ϕA and ϕB terminals.
- G: Line voltage measurement ratings.** This block lists the nominal line-to-neutral “ $\phi-N 120V\sim$ ” voltage, line-to-line “ $\phi-\phi 240V\sim$ ” voltage, and the rated measurement voltage and category “240V CAT III” for this WattNode model. See the [Specifications \(p. 55\)](#) for more information about the measurement voltage and category.
- H: UL Listing mark.** This shows the UL and cUL (Canadian) listing mark and number “3KNN”.
- I: FCC Mark.** This logo indicates that the meter complies with part 15 of the FCC rules.
- J: Status LEDs.** These are status LEDs used to verify and diagnose meter operation. See [Installation LED Diagnostics \(p. 23\)](#) for details.
- K: Current transformer (CT) voltage rating.** These markings “0.333V~” indicate that the meter must be used with CTs that generate a full-scale output of 0.333 Vac (333 millivolts).
- L: DIP switch.** This DIP switch block is used to set the Modbus address and baud rate. See [Setting the Modbus Address \(p. 19\)](#).

M, N, O: Current transformer (CT) inputs. These indicate CT screw terminals. Note the white and black circles at the left edge of the label: these indicate the color of the CT wire that should be inserted into the corresponding screw terminal. The terminals marked with black circles are connected together internally.

P: Auxiliary output terminal. This screw terminal is used for the X terminal options.

Q: Modbus common terminal. This is the common or ground terminal for Modbus EIA RS-485 communication wiring. It is also the common for the X terminal options if they are installed.

R: Modbus signal terminals. These are the RS-485 A- and B+ signals (half-duplex, two-wire). There are several names for these terminals:

- **Inverting pin:** A-, A, -, TxD-, RxD-, D0, and on rare devices “B”
- **Non-inverting pin:** B+, B, +, TxD+, RxD+, D1, and on rare devices “A”

S: Communication status. This LED indicates communication status. See **Modbus Communication Diagnostics (p. 28)** for details.

T: Serial number. This shows meter serial number and options if any are selected. The barcode contains the serial number in Code 128C format.

U: Mains supply rated voltage. This is the rated supply voltage for this model. The **V~** indicates AC voltage. For wye models, this voltage should appear between the **N** and **ΦA** terminals. For delta models, this voltage should appear between the **ΦA** and **ΦB** terminals.

V: Mains frequencies. This indicates the rated mains frequencies for the meter.



W: Maximum rated volt-amps. This is the maximum apparent power consumption (volt-amps) for this model.

X: Manufacture date. This is the date of manufacture for this WattNode meter.

Y: Caution, risk of electrical shock. This symbol indicates that there is a risk of electric shock when installing and operating the meter if the installation instructions are not followed correctly.

Z: Attention - consult Manual. This symbol indicates that there can be danger when installing and operating the meter if the installation instructions are not followed correctly.

Symbols

	Attention - Consult Installation and Operation Manual	Read, understand, and follow all instructions in this Installation and Operation Manual including all warnings, cautions, and precautions before installing and using the product.
	Caution – Risk of Electrical Shock	Potential Shock Hazard from Dangerous High Voltage.
	CE Marking	Complies with the regulations of the European Union for Product Safety and Electro-Magnetic Compatibility. <ul style="list-style-type: none"> ● Low Voltage Directive – EN 61010-1: 2001 ● EMC Directive – EN 61327: 1997 + A1/1998 + A2/2001

Installation

Precautions



DANGER – HAZARDOUS VOLTAGES

WARNING - These installation/servicing instructions are for use by qualified personnel only. To avoid electrical shock, do not perform any servicing other than that contained in the operating instructions unless you are qualified to do so.

Always adhere to the following checklist:

- 1) Only qualified personnel or **licensed electricians** should install the WattNode meter. The mains voltages of 120 Vac to 600 Vac can be lethal!
- 2) Follow all applicable local and national electrical and safety codes.
- 3) Install the meter in an electrical enclosure (panel or junction box) or in a limited access electrical room.
- 4) Verify that circuit voltages and currents are within the proper range for the meter model.
- 5) Use only UL recognized current transformers (CTs) with built-in burden resistors, that generate 0.333 Vac (333 millivolts AC) at rated current. **Do not use current output (ratio) CTs such as 1 amp or 5 amp output CTs: they will destroy the meter and may create a shock hazard.** See [Current Transformers \(p. 59\)](#) for CT maximum input current ratings.
- 6) Ensure that the line voltage inputs to the meter are protected by fuses or circuit breakers (not needed for the neutral wire). See [Circuit Protection \(p. 18\)](#) for details.
- 7) Equipment must be disconnected from the HAZARDOUS LIVE voltages before access.
- 8) The terminal block screws are **not** insulated. Do not contact metal tools to the screw terminals if the circuit is live!
- 9) Do not place more than one line voltage wire in a screw terminal; use wire nuts instead. You may use more than one CT wire per screw terminal.
- 10) Before applying power, check that all the wires are securely installed by tugging on each wire.
- 11) Do not install the meter where it may be exposed to temperatures below -30°C or above 55°C , excessive moisture, dust, salt spray, or other contamination. The meter requires an environment no worse than pollution degree 2 (normally only non-conductive pollution; occasionally, a temporary conductivity caused by condensation must be expected).
- 12) Do not drill mounting holes using the meter as a guide; the drill chuck can damage the screw terminals and metal shavings can fall into the connectors, causing an arc risk.
- 13) If the meter is installed incorrectly, the safety protections may be impaired.

Electrical Service Types

Below is a list of service types, with connections and recommended models. Note: the ground connection improves measurement accuracy, but is not required for safety.

Electrical Service (or Load) Types	Line-to-Neutral (Vac)	Line-to-Line (Vac)	Meter Service Type	Meter Powered by
1 Phase 2 Wire 120V with neutral	96 – 138	n.a.	3Y-208	N and ΦA
1 Phase 2 Wire 230V with neutral (non-U.S.)	184 – 264	n.a.	3Y-400	N and ΦA
1 Phase 2 Wire 277V with neutral	222 – 318	n.a.	3Y-480	N and ΦA
1 Phase 2 Wire 208V no neutral	n.a.	166 – 276	3D-240	ΦA and ΦB
1 Phase 2 Wire 240V no neutral	n.a.	166 – 276	3D-240	ΦA and ΦB
1 Phase 3 Wire 120V/240V with neutral	96 – 138	166 – 276	3Y-208	N and ΦA
			3D-240	ΦA and ΦB
3 Phase 3 Wire Delta 208V no neutral	n.a.	166 – 276	3D-240	ΦA and ΦB
3 Phase 3 Wire Delta 400V no neutral (non-U.S.)	n.a.	320 – 460	3D-400	ΦA and ΦB
3 Phase 3 Wire Delta 480V no neutral	n.a.	384 – 552	3D-480	ΦA and ΦB
3 Phase 4 Wire Wye 120V/208V with neutral	96 – 138	166 – 276	3Y-208	N and ΦA
			3D-240	ΦA and ΦB
3 Phase 4 Wire Delta 120/208/240V with neutral	96 – 138	166 – 276	3D-240	ΦA and ΦB
3 Phase 4 Wire Wye 230V/400V with neutral (non-U.S.)	184 – 264	320 – 460	3Y-400	N and ΦA
			3D-400	ΦA and ΦB
3 Phase 4 Wire Wye 277V/480V with neutral	222 – 318	384 – 552	3Y-480	N and ΦA
			3D-480	ΦA and ΦB
3 Phase 4 Wire Delta 240/415/480V with neutral	222 – 318	384 – 552	3D-480	ΦA and ΦB
3 Phase 4 Wire Wye 347V/600V with neutral	278 – 399	480 – 690	3Y-600	N and ΦA

Table 1: WattNode Models

Single-Phase Two-Wire with Neutral

This configuration is most often seen in homes and offices. The two conductors are neutral and line. For these models, the meter is powered from the **N** and **ΦA** terminals.

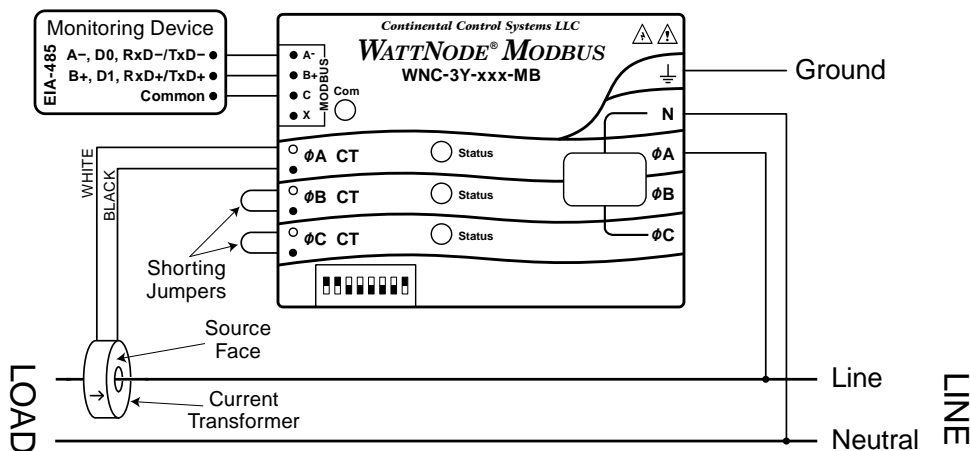

Figure 2: Single-Phase Two-Wire Connection

Recommended WattNode Models

The following table shows the WattNode models that should be used, depending on the line to neutral voltage.

Line to Neutral Voltage	Meter Service Type
120 Vac	3Y-208
230 Vac	3Y-400
277 Vac	3Y-480

Single-Phase Three-Wire (Mid-Point Neutral)

This configuration is seen in North American residential and commercial service with 240 Vac for large appliances. The three conductors are a mid-point neutral and two line voltage wires with AC waveforms 180° out of phase; this results in 120 Vac between either line conductors (phase) and neutral, and 240 Vac (or sometimes 208 Vac) between the two line conductors (phases).

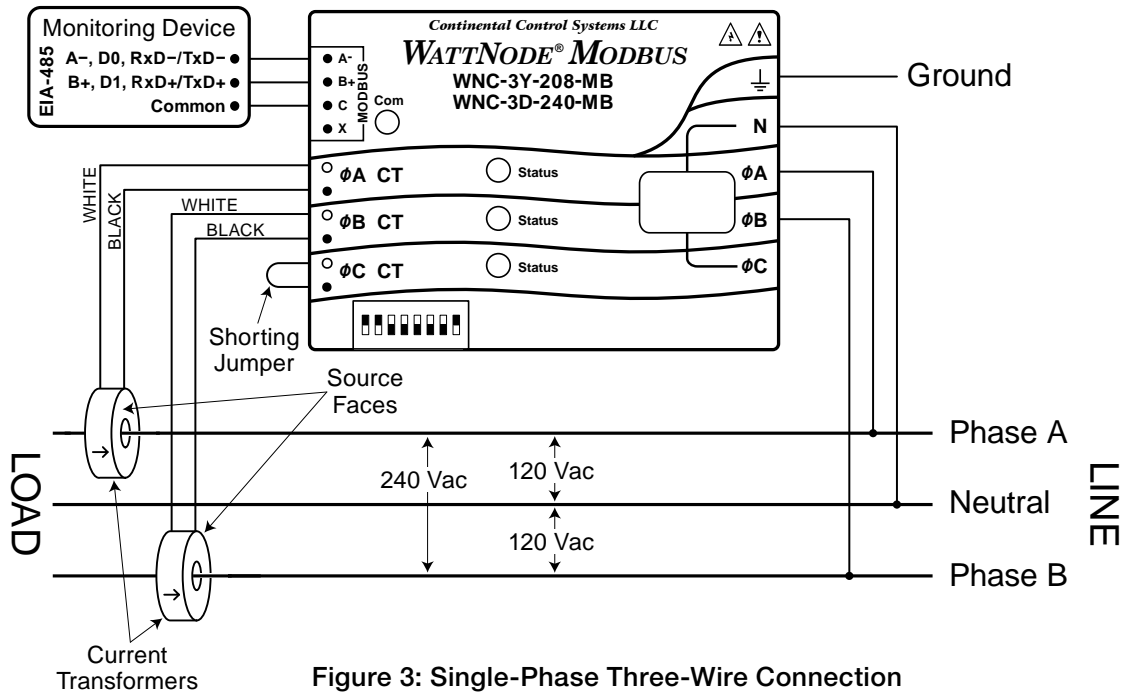

Figure 3: Single-Phase Three-Wire Connection

Recommended WattNode Models

The following table shows the WattNode models that can be used. If neutral may or may not be present, you should use the WNC-3D-240-MB (see **Single-Phase Two-Wire without Neutral** below). If neutral is present, it must be connected for accurate measurements. If phase B may not be present, you should use the WNC-3Y-208-MB (see **Single-Phase Two-Wire with Neutral** above).

Meter Power Source	Meter Service Type
N and φA (Neutral and Phase A)	3Y-208
φA and φB (Phase A and Phase B)	3D-240

Single-Phase Two-Wire without Neutral

This is seen in residential and commercial service with 208 to 240 Vac for large appliances. The two conductors have AC waveforms 120° or 180° out of phase. Neutral is not used. For this configuration, the meter is powered from the ϕA and ϕB (phase A and phase B) terminals.

For best accuracy, we recommend connecting the **N** (neutral) terminal to the ground terminal. This will not cause ground current to flow because the neutral terminal does not power the meter.

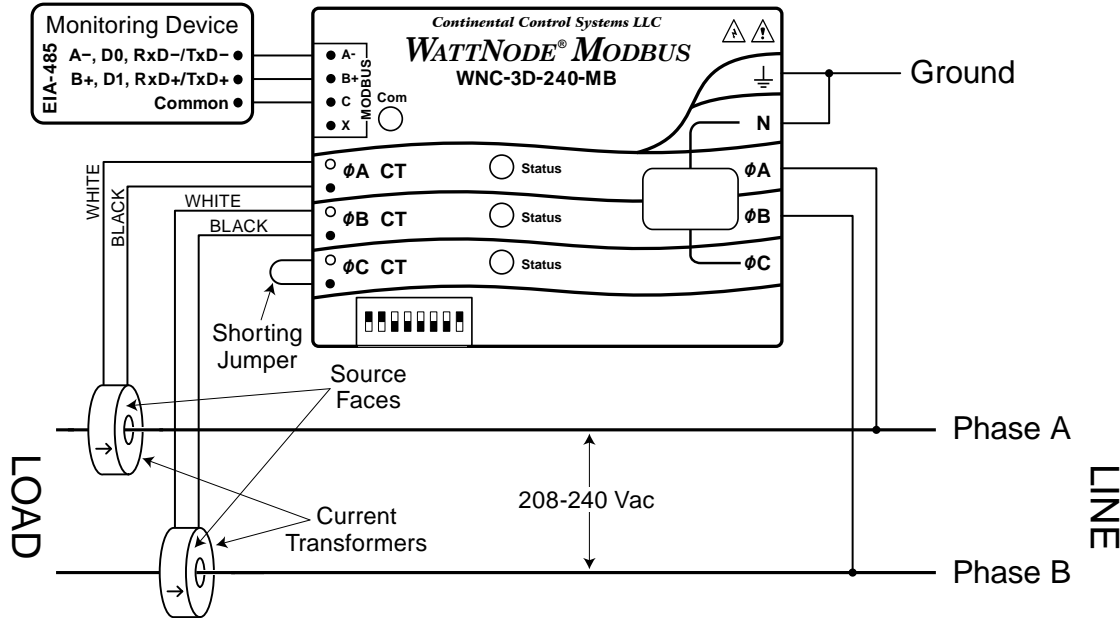

Figure 4: Single-Phase Two-Wire without Neutral Connection

Recommended WattNode Model

This configuration is normally measured with the following WattNode model.

Line-to-Line Voltage	Meter Service Type
208 - 240 Vac	3D-240

If neutral is available, you may also use the WNC-3Y-208-MB model. If you use the WNC-3Y-208-MB, you will need to hook up the meter as shown in section **Single-Phase Three-Wire (Mid-Point Neutral)** and connect neutral. You will need two CTs.

If one of the conductors (phase A or phase B) is grounded, see **Grounded Leg Service** below for recommendations.

Three-Phase Four-Wire Wye

This is typically seen in commercial and industrial environments. The conductors are neutral and three power lines with AC waveforms shifted 120° between phases. The line voltage conductors may be connected to the ϕA , ϕB , and ϕC terminals in any order, **so long as the CTs are connected to matching phases**. It is important that you connect **N** (neutral) for accurate measurements. For wye “-3Y” models, the meter is powered from the **N** and ϕA terminals.

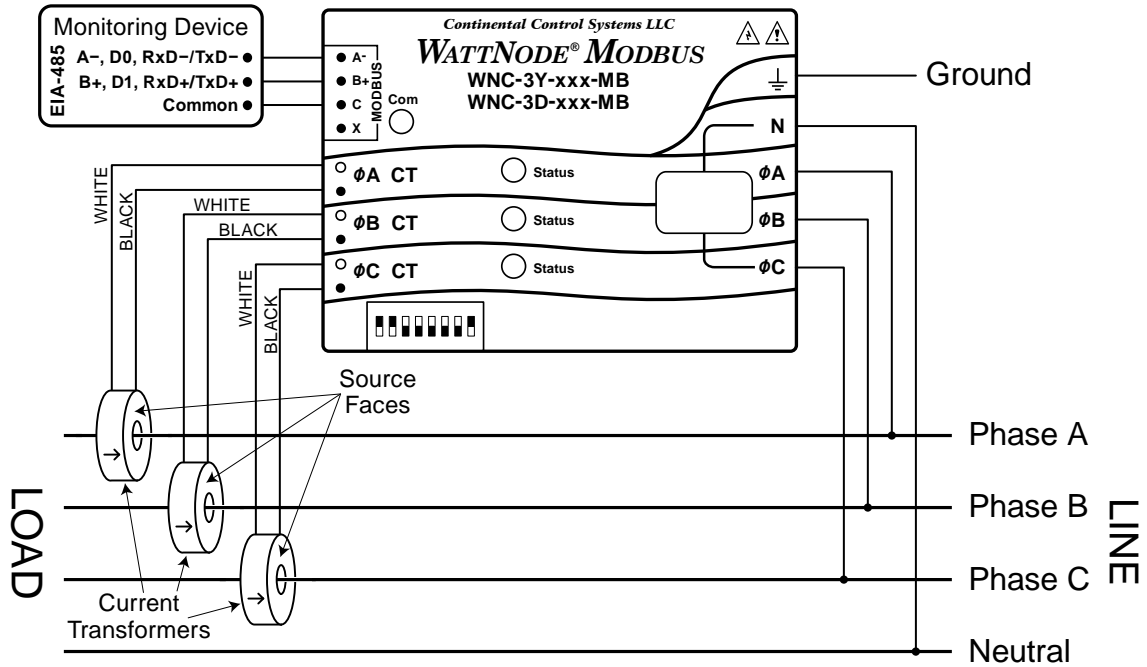

Figure 5: Three-Phase Four-Wire Wye Connection

Recommended WattNode Models

The following table shows the WattNode models that should be used, depending on the line-to-neutral voltage and line-to-line voltage (also called phase-to-phase voltage).

Line-to-Neutral Voltage	Line-to-Line Voltage	Meter Service Type
120 Vac	208 Vac	3Y-208
230 Vac	400 Vac	3Y-400
277 Vac	480 Vac	3Y-480
347 Vac	600 Vac	3Y-600

Note: you may also use the following delta WattNode models to measure three-phase four-wire wye circuits. The only difference is that delta WattNode models are powered from ϕA and ϕB , rather than **N** and ϕA . If neutral is present, it must be connected for accurate measurements.

Line-to-Neutral Voltage	Line-to-Line Voltage	Meter Service Type
120 - 140 Vac	208 - 240 Vac	3D-240
230 Vac	400 Vac	3D-400
277 Vac	480 Vac	3D-480

Three-Phase Three-Wire Delta Without Neutral

This is typically seen in manufacturing and industrial environments. There is no neutral wire, just three power lines with AC waveforms shifted 120° between the successive phases. With this configuration, the line voltage wires may be connected to the ϕA , ϕB , and ϕC terminals in any order, **so long as the CTs are connected to matching phases**. For these models, the meter is powered from the ϕA and ϕB (phase A and phase B) terminals. Note: all delta WattNode models provide a neutral connection **N**, which allows delta WattNode models to measure both wye and delta configurations.

For best accuracy, we recommend connecting the **N** (neutral) terminal to earth ground. This will not cause ground current to flow because the neutral terminal is not used to power the meter.

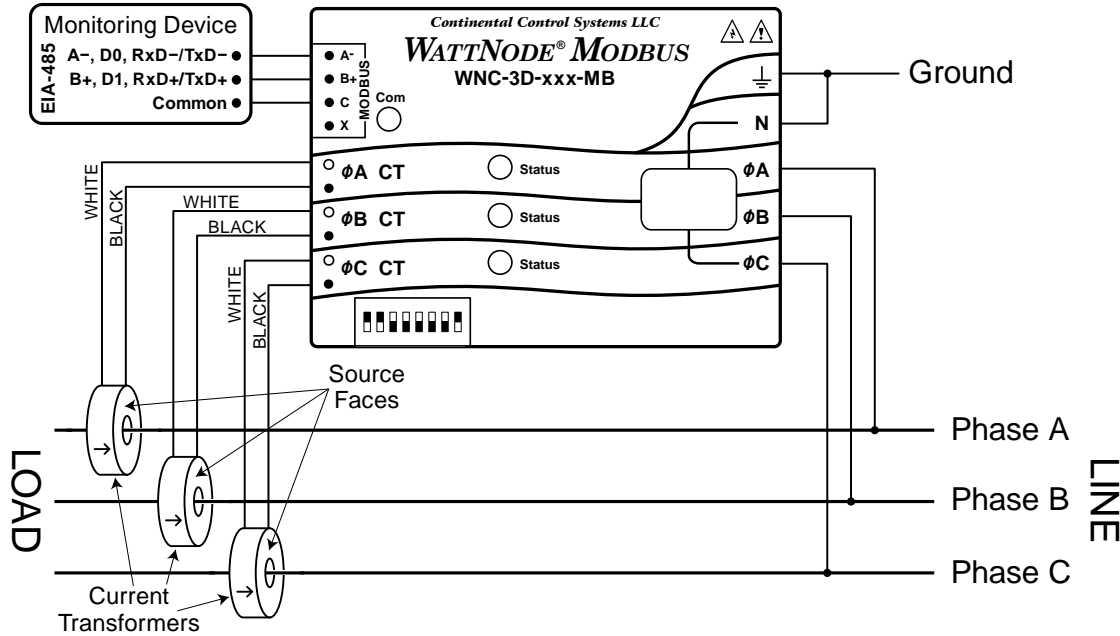

Figure 6: Three-Phase Three-Wire Delta Connection

Recommended WattNode Models

The following table shows the WattNode models that should be used, depending on the line-to-line voltage (also called phase-to-phase voltage).

Line-to-Line Voltage	Meter Service Type
208 - 240 Vac	3D-240
400 Vac	3D-400
480 Vac	3D-480

Three-Phase Four-Wire Delta (Wild Leg)

The uncommon four-wire delta electrical service is a three-phase delta service with a center-tap on one of the transformer windings to create a neutral for single-phase loads.

See http://www.ccontrols.com/w/Four_Wire_Delta_Circuits for details.

Grounded Leg Service

In rare cases with delta services or single-phase two-wire services without neutral, one of the phases may be grounded. You can check for this by using a multimeter (DMM) to measure the voltage between each phase and ground. If you see a reading between 0 and 5 Vac, that leg is probably grounded (sometimes called a “grounded delta”).

The WattNode meter will correctly measure services with a grounded leg, but the measured voltage and power for the grounded phase will be zero and the status LED will not light for whichever phase is grounded, because the voltage is near zero. Also, one or both of the active (non-grounded) phases may indicate low power factor because this type of service results in unusual power factors.

For optimum accuracy with a grounded leg, you should also connect the **N** (neutral) terminal on the meter to the ground terminal; this will not cause any ground current to flow because the neutral terminal is not used to power the meter. If you have a grounded leg configuration, you can save money by removing the CT for the grounded phase, since all the power will be measured on the non-grounded phases. We recommend putting the grounded leg on the **ØB** or **ØC** inputs and attaching a note to the meter indicating this configuration for future reference.

Mounting

Protect the WattNode meter from moisture, direct sunlight, high temperatures, and conductive pollution (salt spray, metal dust, etc.) If moisture or conductive pollution may be present, use an IP 66 or NEMA 4 rated enclosure to protect the meter. Due to its exposed screw terminals, the meter must be installed in an electrical service panel, an enclosure, or an electrical room. The meter may be installed in any orientation, directly to a wall of an electrical panel or junction box.

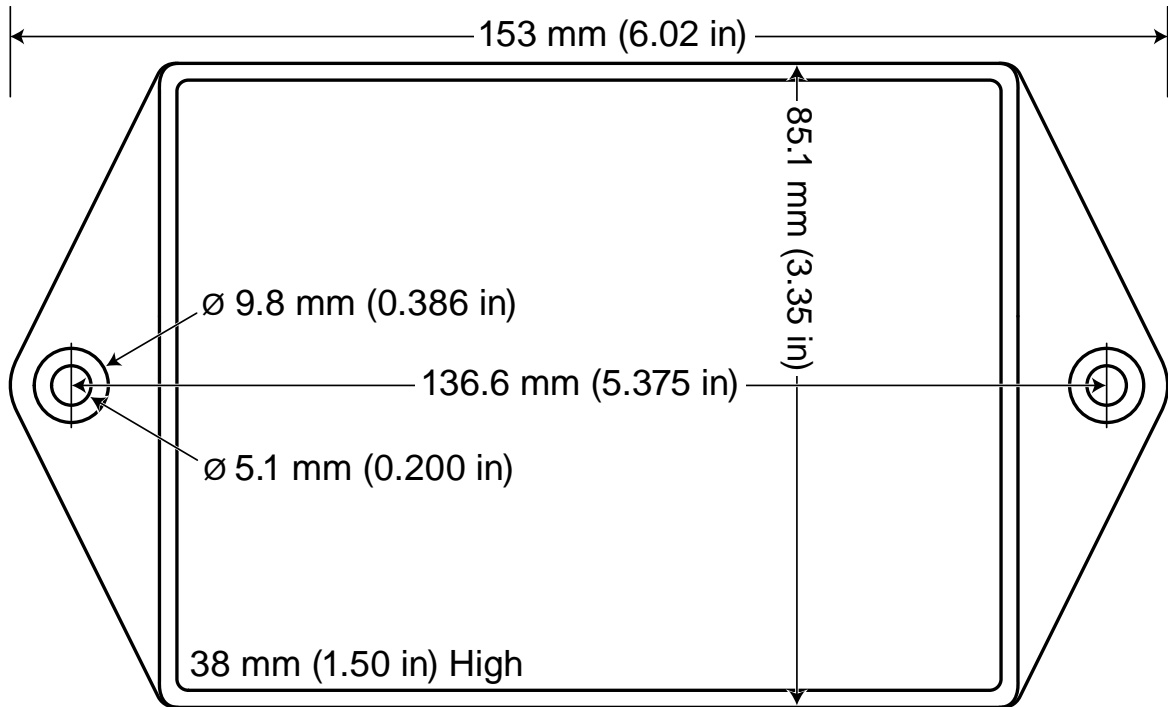

Figure 7: WattNode Meter Dimensions

The WattNode meter has two mounting holes spaced 5.375 inches (137 mm) apart (center to center). These mounting holes are normally obscured by the detachable screw terminals. Remove the screw terminals by pulling outward while rocking from end to end. The meter or **Figure 7** may be used as a template to mark mounting hole positions, but **do not drill the holes with the meter in the mounting position** because the drill may damage the connectors and leave drill shavings in the connectors.

You may mount the meter with the supplied #8 self-tapping sheet metal screws using 1/8 inch pilot hole (3.2 mm). Or you may use hook-and-loop fasteners. If you use screws, avoid

over-tightening which can crack the case. If you don't use the supplied screws, the following sizes should work (**bold** are preferred); use washers if the screws could pull through the mounting holes

Screw Style	U.S.A. UTS Sizes	Metric Sizes
Pan Head or Round Head	#6, #8 , #10	M3.5, M4 , M5
Truss Head	#6 , #8	M3.5 , M4
Hex Washer Head (integrated washer)	#6, #8	M3.5, M4
Hex Head (add washer)	#6, #8 , #10	M3.5, M4 , M5

Table 2: Mounting Screws

Selecting Current Transformers

The rated full-scale current of the CTs should normally be chosen somewhat above the maximum current of the circuit being measured (see **Current Crest Factor** below for more details). In some cases, you might select CTs with a lower rated current to optimize accuracy at lower current readings. Take care that the maximum allowable current for the CT can not be exceeded without tripping a circuit breaker or fuse; see **Current Transformers (p. 59)**.

We only offer CTs that measure AC current, not DC current. Significant DC current can saturate the CT magnetic core, reducing the AC accuracy. Most loads only have AC current, but some rare loads draw DC current, which can cause measurement errors. See our website for more information: http://www.ccontrols.com/w/DC_Current_and_Half-Wave_Rectified_Loads.

CTs can measure lower currents than they were designed for by passing the wire through the CT more than once. For example, to measure currents up to 1 amp with a 5 amp CT, loop the wire through the CT five times. The CT is now effectively a 1 amp CT instead of a 5 amp CT. The effective current rating of the CT is the labeled rating divided by the number of times that the wire passes through the CT.

If you are using the measurement phases of the WattNode (**ΦA**, **ΦB**, and **ΦC**) to measure different circuits, you can use CTs with different rated current on the different phases. Instead of setting one **CtAmps** value for all phases, you can use different values for each phase: **CtAmpsA**, **CtAmpsB**, and **CtAmpsC**.

Current Crest Factor

The term “current crest factor” is used to describe the ratio of the peak current to the RMS current (the RMS current is the value reported by multimeters and the WattNode meter). Resistive loads like heaters and incandescent lights have nearly sinusoidal current waveforms with a crest factor near 1.4. Power factor corrected loads such as electronic lighting ballasts and computer power supplies typically have a crest factor of 1.4 to 1.5. Battery chargers, VFD motor controls, and other nonlinear loads can have current crest factors ranging from 2.0 to 3.0, and even higher.

High current crest factors are usually not an issue when metering whole building loads, but can be a concern when metering individual loads with high current crest factors. If the peak current is too high, the meter's CT inputs can clip, causing inaccurate readings.

This means that when measuring loads with high current crest factors, you may want to be conservative in selecting the CT rated current. For example, if your load draws 10 amps RMS, but has a crest factor of 3.0, then the peak current is 30 amps. If you use a 15 amp CT, the meter will not be able to accurately measure the 30 amp peak current. Note: this is a limitation of the meter measurement circuitry, not the CT.

The following graph shows the maximum RMS current for accurate measurements as a function of the current waveform crest factor. The current is shown as a percentage of CT rated current. For example, if you have a 10 amp load with a crest factor of 2.0, the maximum CT current is approximately 85%. Eighty-five percent of 15 amps is 12.75, which is higher than 10 amps, so

your measurements should be accurate. On the other hand, if you have a 40 amp load with a crest factor of 4.0, the maximum CT current is 42%. Forty-two percent of a 100 amp CT is 42 amps, so you would need a 100 amp CT to accurately measure this 40 amp load.

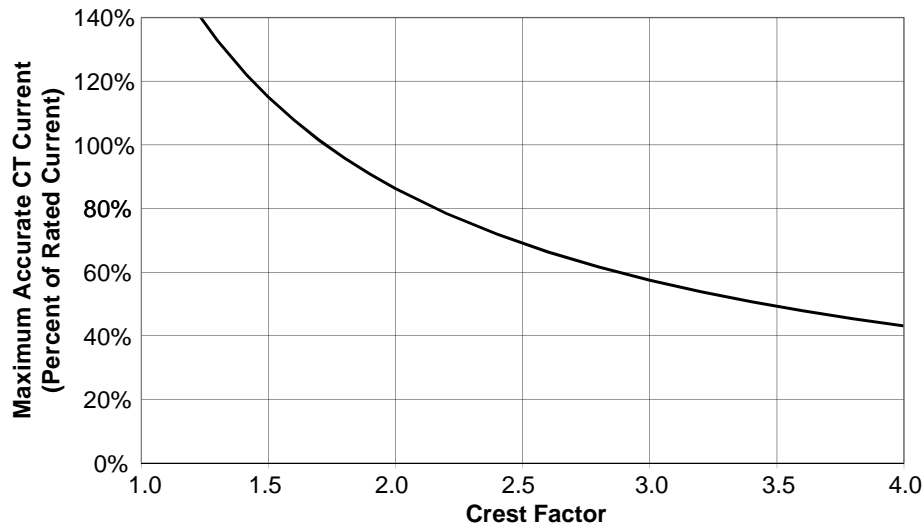

Figure 8: Maximum CT Current vs. Crest Factor

You frequently won't know the crest factor for your load. In this case, it's generally safe to assume the crest factor will fall in the 1.4 to 2.5 range and select CTs with a rated current roughly 150% of the expected RMS current. So if you expect to be measuring currents up to 30 amps, select a 50 amp CT.

Connecting Current Transformers

- Use only UL recognized current transformers (CTs) with built-in burden resistors that generate 0.33333 Vac (333.33 millivolts AC) at rated current. See [Current Transformers \(p. 59\)](#) for the maximum input current ratings.
- **Do not** use ratio (current output) CTs such as 1 amp or 5 amp output CTs: they will **destroy** the meter and present a shock hazard! These are commonly labelled with a ratio like 100:5.
- Find the arrow or label "THIS SIDE TOWARD SOURCE" on the CT and face toward the current source: generally the utility meter or the circuit breaker for branch circuits. If CTs are mounted backwards or with their white and black wires reversed the measured power will be negative. The diagnostic LEDs indicates negative power with flashing red LEDs.
- Be careful to match up the current transformers to the voltage phases being measured. Make sure the **ΦA CT** is measuring the line voltage connected to **ΦA**, and the same for phases B and C. Use the supplied colored labels or tape to identify the wires.
- To prevent magnetic interference, the CTs on different phases should be separated by 1 inch (25 mm). The line voltage conductors for each phase should be separated by at least 1 inch (25 mm) from each other and from neutral.
- For best accuracy, the CT opening should not be much larger than the conductor. If the CT opening is much larger, position the conductor in the center of the CT opening.
- Because CT signals are susceptible to interference, we recommend keeping the CT wires short and cutting off any excess length. It is generally better to install the meter near the line voltage conductors instead of extending the CT wires. However, you may extend the CT wires by 300 feet (100 m) or more by using shielded twisted-pair cable and by running the CT wires away from high current and line voltage conductors.
- OPTIONAL: if you see spurious readings on unused phases, jumper the unused CT inputs.

To connect CTs, pass the wire to be measured through the CT and connect the CT to the meter. **Always remove power before disconnecting any live wires.** Put the line conductors through the CTs as shown in the section **Electrical Service Types (p. 10)**. You may measure generated power by treating the generator as the source.

For solid-core CTs, disconnect the line voltage conductor to install it through the CT opening.

Split-core and bus-bar CTs can be opened for installation around a wire. Different models have different opening mechanisms, so you should familiarize yourself with the CT mechanism before starting the installation. A nylon cable tie can be secured around the CT to prevent inadvertent opening.

Some split-core CT models have flat mating surfaces. When installing this type of CT, make sure that mating surfaces are clean. Any debris between the mating surfaces will increase the gap, decreasing accuracy.

Connect the CT lead wires to the meter terminals labeled **ΦA CT**, **ΦB CT**, and **ΦC CT**. Route the twisted black and white wires from the CT to the meter. Strip 1/4 inch (6 mm) of insulation off the ends of the CT leads and connect to the six position black screw terminal block. Connect each CT lead with the white wire aligned with the white dot on the label, and the black wire aligned with the black dot. Note the order in which the phases are connected, as the voltage phases **must** match the current phases for accurate power measurement.

Record the CT rated current as part of the installation record for each meter. If the conductors being measured are passed through the CTs more than once, then the recorded rated CT current is divided by the number of times that the conductor passes through the CT.

Circuit Protection

The WattNode meter is considered “permanently connected equipment”, because it does not use a conventional power cord that can be easily unplugged. **Permanently connected equipment must have overcurrent protection and be installed with a means to disconnect the equipment.**

- A switch, disconnect, or circuit breaker may be used to disconnect the meter and must be as close as practical to the meter. If a switch or disconnect is used, then there must also be a fuse or circuit breaker of appropriate rating protecting the meter.
- WattNode meters only draw 10-30 milliamps; CCS recommends using circuit breakers or fuses rated for between 0.5 amps and 20 amps and rated for the line voltages and the current interrupting rating required.
- The circuit breakers or fuses must protect the ungrounded supply conductors (the terminals labeled **ΦA**, **ΦB**, and **ΦC**). If neutral is also protected (this is rare), then the overcurrent protection device must interrupt neutral and the supply conductors simultaneously.
- Any switches or disconnects should have at least a 1 amp rating and must be rated for the line voltages.
- The circuit protection / disconnect system must meet IEC 60947-1 and IEC 60947-3, as well as all national and local electrical codes.
- The line voltage connections should be made with wire rated for use in a service panel or junction box with a voltage rating sufficient for the highest voltage present. CCS recommends 14 or 12 AWG (1.5 mm² or 2.5 mm²) stranded wire, rated for 300 or 600 volts. Solid wire may be used, but must be routed carefully to avoid putting excessive stress on the screw terminal.
- The WattNode meter has an earth connection, which should be connected for maximum accuracy. However, this earth connection is not used for safety (protective) earthing.

Connecting Voltage Terminals

Always turn off or disconnect power before connecting the voltage inputs to the meter. Connect each phase voltage to the appropriate input on the green terminal block; also connect ground and neutral (if required).

The voltage inputs to the meter do not need to be powered from the same branch circuit as the load being monitored. In other words, if you have a three-phase panel with a 100 A three-pole breaker powering a motor that you wish to monitor, you can power the meter (or several meters) from a separate 20 A three-pole breaker installed in the same, or even adjacent panel, so long as the load and voltage connections are supplied from the same electric service.

The green screw terminals handle wire up to 12 AWG (2.5 mm²). Strip the wires to expose 1/4" (6 mm) of bare copper. When wiring the meter, do not put more than one wire under a screw. If you need to distribute power to other meters, use wire nuts or a power distribution block. The section [Electrical Service Types \(p. 10\)](#) shows the proper connections for the different meter models and electrical services. **Verify that the voltage line phases match the CT phases.**

If there is any doubt that the meter voltage rating is correct for the circuit being measured, unplug the green terminal block (to protect the meter), turn on the power, and use a voltmeter to compare the voltages (probe the terminal block screws) to the values in the white box on the meter front label. After testing, plug in the terminal block, making sure that is pushed in all the way.

The WattNode meter is powered from the voltage inputs: ϕA (phase A) to **N** (neutral) for wye “-3Y” models, or ϕA to ϕB for delta “-3D” models. If the meter is not receiving at least 80% of the nominal line voltage, it may stop operating. Since the meter consumes a small amount of power itself (typically 1-3 watts), you may wish to power the meter from a separate circuit or place the current transformers downstream of the meter, so its power consumption is not measured

For best accuracy, always connect the **N** (neutral) terminal on the meter. If you are using a delta meter and the circuit has no neutral, then jumper the earth ground to the **N** (neutral) terminal.

When power is first applied to the meter, check that the LEDs behave normally (see [Installation LED Diagnostics \(p. 23\)](#) below): if you see the LEDs flashing red-green-red-green, then disconnect the power immediately! This indicates the line voltage is too high for this model.

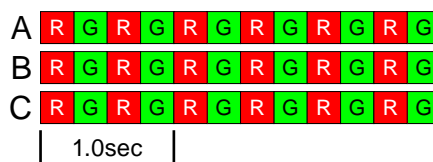

Figure 9: WattNode LED Overvoltage Warning

Setting the Modbus Address

Every device on a Modbus network must have a unique address and the correct baud rate. The WattNode Modbus meter sets the address and baud rate with an eight position DIP switch.

The WattNode meter supports Modbus addresses from 1 to 127 using the DIP switch. Address 0 is used for broadcast messages and is not a valid address. As shipped from the factory, the meter will be configured with an address of 0, which is invalid and will prevent any communication and cause the “**Com**” LED to light solid red.



Set the Modbus address by switching DIP switch positions 1-7, each of which adds a different value to the address. The change will take effect immediately.

DIP Switch	1	2	3	4	5	6	7
Up (1) Value	1	2	4	8	16	32	64
Address	Examples						
1	Up	Down	Down	Down	Down	Down	Down
1+2+4 = 7	Up	Up	Up	Down	Down	Down	Down
4+16 = 20	Down	Down	Up	Down	Up	Down	Down
1+2+16+32+64 = 115	Up	Up	Down	Down	Up	Up	Up

Table 3: Modbus Address Selection

For example, if DIP switch positions 3 and 5 are in the 1 (up) position and the rest are 0 (down), the resulting Modbus address is 4 + 16 = 20.

Once you are communicating with the meter, you can change the address using either the DIP switches or the **Address (1652)** register.

Setting all DIP switch positions to zero for ten seconds resets all communication settings to the factory configuration. If you ordered communication options like **Option EP**, they will be applied. This can be useful if you cannot communicate and need to return the meter to a known state.

Option AD

The WattNode Modbus meter can be ordered from the factory with the Modbus address pre-programmed to any value from 1 to 247 using **Option AD=xxx** where **xxx** is the desired address. If you want to change the address of a meter with Option AD, there are two options:

- 1) **Set the address with the DIP switch:** Set the DIP switches to the desired address, then write 0 to the **Address (1652)** register (to override the factory programmed address). Finally, write 1234 to the **ApplyComConfig (1651)** register to apply the new address.
- 2) **Set the address with the Address register:** Set the DIP switches to any non-zero address so the meter won't reset the address to the factory programmed value. Next write the new address to the **Address (1652)** register. Finally, write 1234 to the **ApplyComConfig (1651)** register to apply the change.

Baud Rate

Select the baud rate by setting DIP switch position 8 as shown below. The change will take effect immediately. The baud rate can be programmed by the factory with **Option 19K** (19,200 baud) or **Option 38K** (38,400 baud), in which case, DIP switch 8 has no effect. You may also use the **BaudRate** register to reprogram the baud rate from 1,200 to 38,400 baud.

Baud Rate	DIP Switch Position 8
9,600 (default)	0 (down)
19,200	1 (up)

Table 4: Baud Rate Selection

Connecting Modbus Outputs

The Modbus WattNode meter communicates using a serial EIA RS-485 interface. The meter uses half-duplex two-wire (plus common) communication, so the same pair of wires is used for sending AND receiving. Up to 127 devices can be connected together on the same RS-485 bus (or up to 247 devices if you assign Modbus addresses using the **Address** register).

Planning the Modbus Network

EIA RS-485 networks should always be wired in a bus (or daisy-chain) configuration. In other words, the bus should start at the PC, Modbus master, or monitoring device and then run to each meter in turn. Try to avoid branches, and avoid home-run wiring (where each meter has its own

wire back to the PC or logger). For best results, especially for longer distances, use wire recommended for RS-485.

Manufacturer	Part Number	AWG	Pairs	Shielded?	Impedance	Insulation
Belden	9841	24	1	Yes	120 ohms	300 V
Belden	9842	24	2	Yes	120 ohms	300 V
many	CAT 5, 5e	24	4	Optional	100 ohms	300 V
many	CAT 6	23 or 24	4	Optional	100 ohms	300 V

Table 5: Recommended RS-485 Cabling

- Since the Modbus / RS-485 wiring may be located near line voltage wiring, use wires or cables rated for the highest voltage present, generally 300 V or 600 V rated wire.
- If this cable will be in the presence of bare conductors, such as bus-bars, it should be double insulated or jacketed.
- Use twisted-pair cable (unshielded or shielded) to prevent interference.

Because the WattNode meter uses half-duplex communication, it only needs a single twisted-pair, but it also **needs a conductor for common**, which may be the shield or a spare conductor.

Length Limits

Under ideal conditions, using cable with a 120 ohm impedance and proper termination, it should be possible to run RS-485 signals 1200 m (4000 ft) at up to 19,200 baud. However, a number of factors can reduce this range, including electrical and magnetic interference (EMI), bus loading, poor termination, etc. Repeaters are available to extend the range if necessary.

If it isn't convenient to daisy-chain the main RS-485 bus to each meter, you may use stubs or branches. Long stubs or branches—greater than 30 m (100 ft)—may cause signal reflections and should be avoided.

Termination

Networks shorter than 500 m (1650 ft) should not need termination. Longer networks and networks in electrically noisy environments may need termination at both ends of the bus with 120 ohm resistors between the “**A-**” and “**B+**” terminals. Generally, you will put one termination resistor at the PC or monitoring device and one at the meter farthest from the monitoring device.

Some EIA RS-485 PC interfaces include jumpers or switches to provide internal termination at one end of the bus.

In some cases, termination can cause problems. It dramatically increases the load on the bus, so that some RS-485 PC interfaces cannot handle the load (particularly port powered ones). Also, adding 120 ohm termination resistors may require the addition of bias resistors (see next section).

Biasing

EIA RS-485 networks frequently use bias resistors to hold the bus in a “high” or logic 1 state when no devices are transmitting. In this state, the Modbus “**A-**” terminal is more negative than the “**B+**” terminal. Without bias resistors, the bus can float and noise can appear as bogus data.

The WattNode meter uses an RS-485 failsafe transceiver that eliminates the need for bias resistors except in noisy environments. Furthermore, many RS-485 PC interfaces include internal bias resistors, so it is rare to need to add bias resistors.

If you determine that your network is experiencing noise problems, then you may want to add termination and possibly bias resistors.

Wiring

Once you've planned the network and strung the cable, you can connect the WattNode meters.

- The Modbus terminals (**A-**, **B+**, **C**, and **X**) are completely isolated (4500 Vac RMS isolation) from dangerous voltages, so you can connect them with the meter powered. They are also isolated from the meter's earth ground and neutral connections.
- When connecting WattNode meters to a PC or monitoring device, connect all "**A-**" terminals together, all "**B+**" terminals together, and all "**C**" (common) terminals together. In most cases, if you swap "**A-**" and "**B+**", WattNode Modbus meters can auto-detect the polarity and communicate correctly. **Note:** if your RS-485 network isn't properly biased (one terminal more positive than the other), then the auto-detect feature will not work.
- You may put two sets of wires in each screw terminal to make it easier to daisy-chain the network from one device to the next. If you do this, we recommend that you twist the wires tightly together before putting them into the screw terminal to ensure that one wire doesn't pull free, causing communication problems.
- If you are using shielded cable, you may use the shield to provide the Modbus common "**C**" connection between all devices on the network.
- Connect the cable shield or Modbus common (if there is no shield) to earth ground at just the Modbus master end of the cable. Grounding both ends can cause ground loops. Leaving the common floating risks damaging the RS-485 circuitry.

Installation Summary

- 1) Mount the WattNode meter.
- 2) Turn off power before installing solid-core (non-opening) CTs or making voltage connections.
- 3) Mount the CTs around the line voltage conductors being measured. Take care to orient the CTs facing the source of power.
- 4) Connect the twisted white and black wires from the CT to the six position black terminal block on the meter, matching the wire colors to the white and black dots on the front label.
- 5) Connect the voltage wires including ground and neutral (if present) to the green terminal block, and check that the current (CT) phases match the voltage measurement phases.
- 6) Set the Modbus network address and baud rate with the DIP switches.
- 7) Connect the pulse output terminals of the meter to the monitoring equipment.
- 8) Apply power to the meter.
- 9) Verify that the LEDs light correctly and do not indicate an error condition.

Installation LED Diagnostics

The WattNode meter includes multi-color power diagnostic LEDs for each phase to help verify correct operation and diagnose incorrect wiring. The LEDs are marked “Status” on the label. The following diagrams and descriptions explain the various LED patterns and their meanings. The A, B, and C on the left side indicate the phase of the LEDs. Values like “1.0sec” and “3.0sec” indicate the time the LEDs are lit in seconds. In the diagrams, sometimes the colors are abbreviated: R = red, G or Grn = green, Y = yellow.

Normal Startup

On initial power-up, the LEDs will all light up in a red, yellow, green sequence. After this startup sequence, the LEDs will show the status, such as **Normal Operation** below.

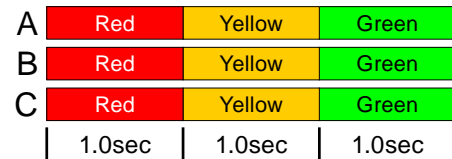

Normal Operation

During normal operation, when positive power is measured on a phase, the LED for that phase will flash green. Typical flash rates are shown below.



Percent of Full-Scale Power	LED Flash Rate	Flashes in 10 Seconds
100%	5.0 Hz	50
50%	3.6 Hz	36
25%	2.5 Hz	25
10%	1.6 Hz	16
5%	1.1 Hz	11
1% (and lower)	0.5 Hz	5

Table 6: LED Flash Rates vs. Power

Zero Power

For each phase, if line Vac is present, but the measured power is below the minimum that the meter will measure; see **Creep Limit (p. 57)**, the meter will display solid green for that phase.



Inactive Phase

If the meter detects no power and line voltage below 20% of nominal, it will turn off the LED for the phase.

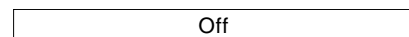

Negative Power

If one or more of the phase LEDs are flashing red, it indicates negative power (flowing into the grid) on those phases. The rate of flashing indicates magnitude of negative power (see **Table 6** above). This can happen for the following reasons:

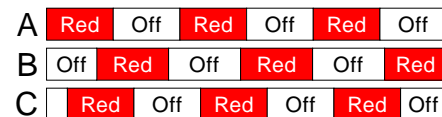

- This is a bidirectional power measurement application, such as a photovoltaic system, where negative power occurs whenever you generate more power than you consume.
- The current transformer (CT) for this phase was installed backwards on the current carrying wire or the white and black wires for the CT were reversed at the meter. This can be solved by flipping the CT on the wire or swapping the white and black wires at the meter. Alternatively, you can use the configuration register **CtDirections (1607)** to reverse the polarity of one or more of the CTs.

- The CT wires are connected to the wrong inputs, such as if the CT wires for phases B and C are swapped or the CT wires are rotated one phase.

Note: if all three LEDs are flashing red and they always turn on and off together, like the diagram for **Low Line Voltage** below, then the meter is experiencing an error or low line voltage, not negative power.

Erratic Flashing

If the LEDs are flashing slowly and erratically, sometimes green, sometimes red, this generally indicates one of the following:

- Earth ground is not connected to the meter (the top connection on the green screw terminal).
- Voltage is connected for a phase, but the current transformer is not connected, or the CT has a loose connection.
- In some cases, particularly for a circuit with no load, this may be due to electrical noise. This is not harmful and can generally be disregarded, provided that you are not seeing substantial measured power when there shouldn't be any. Try turning on the load to see if the erratic flashing stops.

To fix this, try the following:

- Make sure earth ground is connected.
- If there are unused current transformer inputs, install a shorting jumper for each unused CT (a short length of wire connected between the white and black dots marked on the label).
- If there are unused voltage inputs (on the green screw terminal), connect them to neutral (if present) or earth ground (if neutral isn't available).
- If you suspect noise may be the problem, try moving the meter away from the source of noise. Also try to keep the CT wires as short as possible and cut off excess wire.



Meter Not Operating

It should not be possible for all three LEDs to stay off when the meter is powered, because the phase powering the meter will have line voltage present. Therefore, if all LEDs are off, the meter is either not receiving sufficient line voltage to operate, or is malfunctioning and needs to be returned for service. Verify that the voltage on the Vac screw terminals is within $\pm 20\%$ of the nominal operating voltages printed in the white rectangle on the front label.

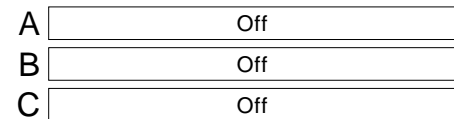

Meter Error

If the meter experiences an internal error, it will light all LEDs red for three seconds or longer. Check the **ErrorStatus (1710)** register to determine the exact error. If this happens repeatedly, return the meter for service.

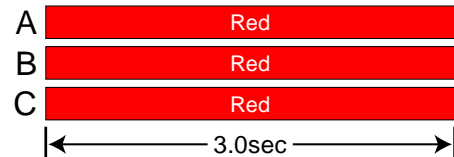

Bad Calibration

This indicates that the meter has detected bad calibration data and must be returned for service.



Line Voltage Too High

Whenever the meter detects line voltages over 125% of normal for one or more phases, it will display a fast red/green flashing for the affected phases. This is harmless if

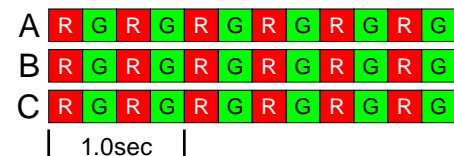

it occurs due a momentary surge, but if the line voltage is high continuously, **the power supply may fail. If you see continuous over-voltage flashing, disconnect the meter immediately!** Check that the model and voltage rating is correct for the electrical service.

Bad Line Frequency

If the meter detects a power line frequency below 45 Hz or above 70 Hz, it will light all the LEDs yellow for at least three seconds. The LEDs will stay yellow until the line frequency returns to normal. During this time, the meter should continue to accurately measure power. This can occur in the presence of extremely high noise, such as if the meter is too close to an unfiltered variable frequency drive.

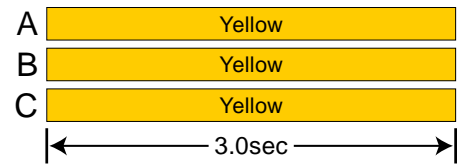

Low Line Voltage

These LED patterns occur if the line voltage is too low for the meter to operate correctly and the meter reboots repeatedly. The pattern will be synchronized on all three LEDs. Verify that the voltage on the Vac screw terminals is not more than 20% lower than the nominal operating voltages printed in the white rectangle on the front label. If the voltages are in the normal range and the meter continues to display one of these patterns, return it for service.

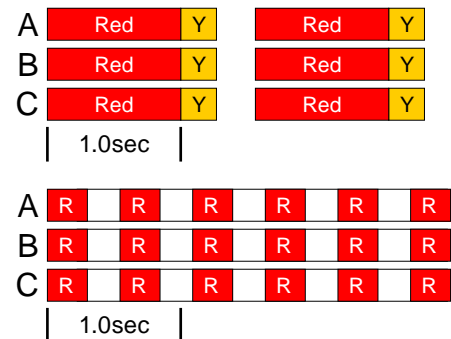

No Line Voltage

If the measured line voltage on all three phases is less than 20% of the nominal line Vac, then the meter will briefly flash all three status LEDs together every three seconds. This is very rare, but can indicate the following:

- You have purchased a DC instrument powered WattNode meter and the meter has power, but the circuit being monitored is off. You can check for this by measuring the AC volts from neutral to each phase or between phases for delta circuits.

The measurement circuitry has been damaged and cannot read the line voltages.

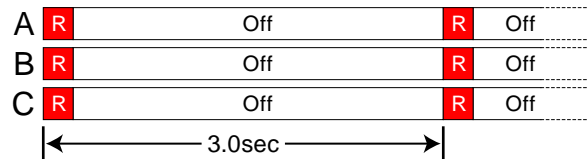

Other Fixed Pattern

If you see any other steady (non-flashing) pattern, contact Continental Control Systems for support.

Measurement Troubleshooting

There are a variety of possible measurement problems. The following procedure should help narrow down the problem. This assumes you can communicate with the meter and read registers. You can combine these diagnostic steps with the status LED diagnostics above.

Voltage

Start by checking the reported voltage (**VoltA**, **VoltB**, **VoltC**) for active (connected) phases. Make sure the voltages match the expected line-to-neutral voltages (or line-to-ground for delta circuits). You should check the actual voltages present at the WattNode meter with a DMM (multimeter) if possible.

- If one or more voltages are zero, then you either have a wiring problem or something is wrong with the meter. Verify the actual voltages with a DMM (multimeter). In rare cases, with delta circuits, one phase may be grounded and will read zero volts.

- If one or more voltages are too low (by more than 5%), then make sure you have the correct model. For example, a WNC-3Y-208-MB expects line-to-neutral voltages of 120 Vac and can measure up to about 150 Vac. If you apply 208 Vac line-to-neutral, the WattNode meter will read a voltage in the 150 Vac to 180 Vac range.
- If any voltages read high, then check your wiring. If the wiring is correct, contact support.
- If the voltages are close to the measured (or expected) values, continue with the next step.

Power

Next, check the measured power for each active phase (**PowerA**, **PowerB**, **PowerC**). If possible, estimate or measure the actual power. Also, make sure the load you are measuring is currently on.

- If one or more active phases are reporting zero power, then the problem is probably one of the following:
 - There is no active power (the load is off) or the power is too low to measure (generally less than 1/1000th of full-scale).
 - CT wires are not securely connected.
 - The CT or its wires are damaged.
 - There is strong electrical interference, as might occur if the meter is in very close proximity to a variable speed drive (also called variable frequency drive or inverter).
 - The meter is not working correctly: try swapping it with a replacement WattNode meter.
- If one or more active phases are reporting negative power:
 - The current transformer has been installed backward on the wire being measured. CTs are marked with either an arrow or a label saying “This side toward source”. If the arrow or label are not oriented toward the source of power (generally the panel or breaker), then the measured current will be inverted and the power negative. This can be fixed either by flipping the CT or by swapping the white and black wires where they enter the meter.
 - The current transformer white and black wires have been swapped where they enter the WattNode meter (at the black screw terminal block).
 - The line voltage phases (green screw terminals) are not matched up with the current phases (black screw terminals). For example, the phase A CT is around the phase B wire.
 - This may be normal if you are measuring in an environment where power may be consumed or generated, such as a house with PV panels.
- If one or more phases are reporting low or high power:
 - Make sure the **CtAmps** configuration is set correctly for your current transformers.
 - The current transformers may have a rated current too high or too low for your application. CTs should be used between 1% and 100% of their rated current for best results. They generally work with reduced accuracy as low as 0.5% to 0.1% of rated current.
 - The CTs may not be installed properly. Check for: CTs touching each other or pre-existing CTs; CT opening too large for the conductor being measured.
 - The voltage phases (green screw terminal block) are not matched up with the current phases (black screw terminal block). The easiest way to determine this is to skip ahead to the next troubleshooting section: **Power Factor and Reactive Power**.
 - Interference from a variable frequency or variable speed drive: VFD, VSD, inverter, or the like. Generally, these drives should not interfere with the WattNode meter, but if they are in very close proximity, or if the CT leads are long, interference can occur. Try moving the WattNode meter at least three feet (one meter) away from any VFDs. Use short CT leads if possible. **NEVER** install the meter downstream of a VFD: the varying line frequency and extreme noise will cause problems!

- Our current transformers can only measure AC currents. Strong DC currents will saturate the magnetic core of the CT, preventing an accurate measurement of the AC current. The overwhelming majority of AC powered electric devices do not draw significant DC current, so this is a rare occurrence.
- Loads with a high current crest factor (ratio of the peak current to the RMS current) can cause clipping in the measurement circuitry, resulting in lower than expected readings. You can check for this with a handheld power quality analyzer that can measure crest factor (CF) or by trying a CT with a higher rated current, which should allow the meter to measure the peak current accurately.
- The CTs may be malfunctioning. If possible, use a current clamp to verify the current, then use a DMM (multimeter) to measure the AC voltage between the white and black wires from the CT (leave them connected to the meter during this test). At rated current, the CT output voltage should equal 0.333 Vac (333 millivolts AC). At lower currents, the voltage should scale linearly, so at 20% of rated current, the output voltage should be $0.20 * 0.333 = 0.0666$ Vac (66.6 millivolts AC).
- If possible, verify the expected power with a handheld power meter. Current clamps can be useful to very roughly estimate the power, but since they measure current, not power, the estimated power (voltage times current) may be off by 50% or more.

Power Factor and Reactive Power

The measured power factor and reactive power are very useful in determining if there is a phasing mismatch between the voltage and current measurement phases on the meter. For example, if the phase A CT is around the phase B wire.

However, this troubleshooting is complicated because different loads have different typical power factors and the power factor can vary significantly for some devices, like motors, as a function of the mechanical load on the motor. Here are some general guidelines:

- **Motors, idling or with a light load:** power factor from 0.1 to 0.6, positive reactive power.
- **Motors, normal or heavy load:** power factor from 0.5 to 0.8, positive reactive power.
- **Motor with VSD:** power factor between 0.5 and 0.9.
- **Incandescent lighting:** power factor near 1.0, small negative reactive power.
- **Florescent lighting:** power factor between 0.4 and 1.0.
- **Electrical heating:** power factor near 1.0.
- **Office equipment:** power factor between 0.6 and 1.0, reactive power may be positive or negative.

Negative power factor values either indicate you are generating power (as with a PV system) or that the CTs are reversed.

If the measured power factor or reactive power appears to be outside the normal ranges, this most commonly indicates that the voltage and current phases on the meter are not connected properly, although some loads fall outside the normal ranges. Check the following:

- The CT connected to the **ϕA CT** terminal is installed around the line wire being measured by the **ϕA** Vac terminal (green terminal block).
- The CT connected to the **ϕB CT** terminal is installed around the line wire being measured by the **ϕB** Vac terminal (green terminal block).
- The CT connected to the **ϕC CT** terminal is installed around the line wire being measured by the **ϕC** Vac terminal (green terminal block).

If this doesn't solve your problem, contact technical support for more assistance.

Modbus Communication Diagnostics

The “**Com**” LED indicates many Modbus communication conditions by lighting green, yellow, or red. Other Modbus errors are indicated by returning a Modbus exception response to the master and by saving an error code to the ***ErrorStatus*** registers.

Modbus Idle

Whenever the Modbus network is idle, the **Com** LED will stay off.

Received Packet / Sending Response

Every time the meter receives a properly formatted packet it will light the LED green for 200 milliseconds.

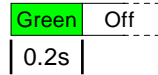

Other Modbus Activity

If the WattNode meter sees packets on the bus addressed to other devices, it will light the LED yellow for 200 milliseconds or longer if the packet duration is longer than 200 milliseconds.

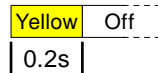

Modbus Address Zero Invalid

Modbus address 0 is reserved for broadcast

messages, so if the DIP switch is set for address zero, the **Com** LED will light red continuously and the meter will not respond to any Modbus packets.



Modbus Address Conflict or Bus Contention

The meter displays this indication in these cases:

- It sees unexpected data on the RS-485 bus when it is preparing to respond to a command. This generally is due to another WattNode meter with the same address responding first, although it could also be extra bytes from the Modbus master or another device.
- It starts transmitting a response, but doesn't see the data it is transmitting on the RS-485 bus. This can happen if two devices have the same address and start transmitting at nearly the same time. It can also be caused by a short circuit on the bus or extreme interference.
- Your RS-485 adapter is configured for full duplex (four wire) operation instead of half-duplex.
- Your RS-485 adapter is continuing to drive the transmit lines after sending a packet; this can happen with older RS-232 to RS-485 adapters that require an RTS signal to transmit.

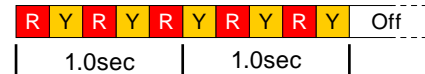

If you see this indication, make sure there are not two meters with the same Modbus address. You may want to disconnect all but one meter to see if the problem goes away.

Invalid Modbus Packet

The meter will light the **Com** LED red for one second for any of the following errors (the ***ErrorStatus*** registers will also be set, but depending on the problem you may not be able to read register values).

- **CRC error:** this could indicate noise on the RS-485 bus.
- **Framing error:** this normally indicates a bad baud rate or noise on the RS-485 bus. This can happen if you have the “**A-**” and “**B+**” wires swapped and your network isn't properly biased. Properly biased networks will transparently auto-detect that “**A-**” and “**B+**” wires are swapped and correct. **Note:** some RS-485 PC interfaces label “A” and “B” the opposite of the WattNode meter or just use “+” and “-” indications.
- **Buffer overrun error:** the packet was longer than 256 bytes.
- **Parsing error:** the packet could not be correctly parsed as a Modbus packet.



Invalid Request

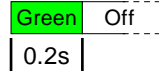

If the WattNode Modbus meter receives a **valid packet**, but with an **invalid request** (see below), then the meter will respond with a Modbus exception message and store an error in the **ErrorStatus** registers. Because the packet was valid, **Com** LED will flash green for 200 milliseconds.

Modbus Exceptions

If the meter receives an invalid request, it will reply with a Modbus exception code. In most cases, your PC software should be able to display the code, which should help you determine the problem. For more information about the problem, check the **ErrorStatus** registers, which will provide more detailed error codes.

- **01 - Illegal function code**
 - ErrorStatus 213: The Modbus function code is not supported by the WattNode meter, such as **07 Read Exception Status**.
- **02 - Illegal data address**
 - ErrorStatus 206: Attempted to read an invalid register address or write to a read-only register. This is common if your addresses are off by one or you request extra registers.
 - ErrorStatus 203: A partial 32 bit write (a dual register like **ConfigPasscode**) was aborted by a write to an unrelated register.
- **03 - Illegal data value**
 - ErrorStatus 202: When changing the **ConfigPasscode**, the confirmation entry didn't match the first entry.
 - ErrorStatus 205: Invalid **ConfigPasscode** value entered. You will have to wait five seconds to try again.
 - ErrorStatus 207, 208: An attempt was made to write an illegal data value to a register.
 - ErrorStatus 211, 212: The Modbus packet contained an invalid count of registers or an invalid byte count.
- **04 - Slave device failure**
 - ErrorStatus 200: The correct **ConfigPasscode** must be entered before changing configuration registers, or resetting the energy or demand registers.
 - ErrorStatus 19, 20, 72, 79, 80, 215: Internal hardware failure.
 - ErrorStatus 67: Calibration data lost. The WattNode meter will report a slave device failure until it is calibrated.
- **06 - Slave device busy**
 - ErrorStatus 209: Attempts to unlock the configuration with **ConfigPasscode** are locked out for five seconds after entering an invalid passcode.

Review Diagnostic Registers

If Modbus communications are working, but with intermittent problems, check the following diagnostic registers (see **Diagnostic Registers (p. 51)** for details): **ErrorStatus**, **CrcErrorCount**, **FrameErrorCount**, **PacketErrorCount**, **OverrunCount**.

Operating Instructions

Quick Start

To start communicating with a WattNode Modbus meter using a PC, you'll need to complete the following steps:

- Set the Modbus address and baud rate using the DIP switches (see [Setting the Modbus Address \(p. 19\)](#)).
- Find and install Modbus software for your PC. For a list of some low-cost programs, see http://www.ccontrols.com/w/Modbus_Software.
- Find and install an EIA RS-485 interface for your PC. The most common versions are RS-232 to RS-485 converters and RS-485 USB interfaces (Ethernet and PCI adapters are also available). The RS-485 USB interfaces are generally the best choice, because they are USB powered and don't require a serial port on your PC.
- Configure your Modbus software for the correct baud rate, COM port, Modbus RTU (not Modbus ASCII), N81 parity (no parity, eight data bits, one stop bit), and the WattNode meter's Modbus address. If you have ordered **Option EP**, then use even parity (E81) instead.

Now you should be able to send commands to the WattNode meter and receive responses. As a test, try reading the integer frequency register at **1221**. Be sure to request only one register: some software defaults to reading 100 registers, which will cause an exception. You should see the AC line frequency times 10 (approximately 600 for 60 Hz power). If you don't get a good response, check the section [Modbus Communication Diagnostics \(p. 28\)](#).

WattNode Basic Configuration

- Set the **CtAmps (1603)** register to the correct rated CT amps of your current transformers. For example, if you are using 100 A CTs, write 100 to register **1603** (16 bit integer register).
- If you are planning on using demand measurements and you don't want to use the default 15 minute interval, you should set the **DemPerMins** as well.

Verify Operation

You should be able to read several registers to check that the meter is correctly installed and measuring power and energy. If your Modbus software supports floating point Modbus registers, you may want read from the set [Basic Register List - Floating Point \(p. 34\)](#). If you cannot easily read floating point values, use [Basic Register List - Integer \(p. 34\)](#) instead. Verify registers in the following sequence:

- **Freq (power line frequency)**: should be near 50 or 60 Hz (or 500 or 600 if you are reading the integer registers).
- **VoltA, VoltB, VoltC**: should match your line-to-neutral voltage.
- **PowerA, PowerB, PowerC**: should be positive (unless you are measuring something that can generate power like a PV system) and in a reasonable range for the load being measured (make sure your load is ON). Note: the integer power registers are scaled, so if you expect to see 75,000 W (75 kW) and instead you see 7500, that is probably because the meter is reporting integer power in 10 W increments. See [PowerIntScale](#) for details.
- **ErrorStatus**: this will return 0 if there are no errors. If you see any non-zero values, write them down and check the [Diagnostic Registers \(p. 51\)](#) section below to determine the problem.

If you are measuring floating point values and the numbers are way off, your software may be combining the floating point registers in the wrong order. Compare the values to the integer registers and check to see if your software has an option like "Float - swapped" or "Float - reversed"; if so, see if this fixes the problem.

- If you don't get reasonable results, check [Measurement Troubleshooting \(p. 25\)](#) above.

Measurement Overview

The WattNode meter performs measurements every one second. The measurements are used to update three types of registers:

- **Energy registers:** These accumulate up (or sometimes down) based on the consumed energy during each measurement period. Energy values are preserved across power failures.
- **Instantaneous registers:** These are non-accumulating values, like power, volts, current, etc. These are not preserved across power failures.
- **Demand registers:** these accumulate data from each measurement, but the reported demand values only update at the completion of a demand interval (or subinterval), which is typically every 15 minutes. Only the peak demand values are preserved across power failures.

Modbus Communication

The WattNode Modbus meter uses Modbus RTU communication. For full specifications, see <http://www.modbus.org/specs.php>. Modbus RTU is a binary protocol consisting of message frames. Each frame contains a one byte address, a one byte function code, a variable number of data bytes, and a two byte CRC. The end of a frame is signalled by a pause with no bytes transmitted; the pause duration must be at least equivalent to 3.5 character (byte) periods. At 9600 baud the pause must last 3.6 milliseconds.

The Modbus RTU serial specification requires that the default serial protocol use 8 data bits, even parity, and one stop bit. However, very few devices follow this part of the Modbus standard, so the WattNode meter defaults to 8 data bits, no parity, and one stop bit instead. If your application requires even parity, order **Option EP** or change the parity using the **ParityMode** register.

The Modbus protocol is a master/slave protocol, with only one master and many slaves. The WattNode meter is always a slave device, and responds only when queried.

Modbus on EIA RS-485 allows for either full-duplex or half-duplex communication, but the WattNode meter only supports half-duplex, meaning that the same wires are used both for transmitting and receiving and only one device can be transmitting at a time. To avoid conflicts (two devices trying to transmit at the same time), the Modbus protocol only allows the master to initiate a request. After the master has finished transmitting, if the meter has received a valid packet addressed for it, then the meter transmits its response.

Modbus Functions

In most cases, your Modbus software will automatically use the correct Modbus command for any action you wish to perform, so you may be able to skip this section. The Modbus specifications list numerous possible commands, but the WattNode meter only supports the following:

- **03 (0x03) - Read Holding Registers:** Holding registers can be read and written and are intended for configuration values, but the WattNode meter treats input registers and holding registers interchangeably, so you can use functions 04 or 03 to read any registers.
- **04 (0x04) - Read Input Registers:** Input registers are generally read-only and report power, energy, and related values. The WattNode meter treats input registers and holding registers as interchangeable, so you can use functions 04 or 03 to read any registers.
- **06 (0x06) - Write Single Register:** This writes a new value to a single register.
- **16 (0x10) - Write Multiple Registers:** This writes a new value to a range of registers.
- **17 (0x11) - Report Slave ID:** This returns a packet containing an ASCII text identification string. See the next section for details.

Other functions will result in Modbus exception **01 - Illegal Function Code**.

Report Slave ID

The report slave ID function returns the following standard packet:

Name	Length	Value	Description
Address	1 byte	Varies	Modbus Address of the meter
Function Code	1 byte	0x11	Report Slave ID function code
Byte Count	1 byte	Varies	Number of bytes in Slave ID, Run Indicator Status, and Additional Data
Slave ID	1 byte	0x02	WattNode meter Slave ID byte
Run Indicator Status	1 byte	0xFF = ON	Always returns 0xFF
Additional Data	Variable, typically 64	ASCII string, null terminated	Example: "Continental Control Systems LLC, WattNode MODBUS, WNC-3Y-208-MB"
CRC	2 bytes	Varies	Packet checksum

Table 7: Report Slave ID Response

The standard values for the Additional Data field follow:

WattNode Model	Response String
WNC-3Y-208-MB	Continental Control Systems LLC, WattNode MODBUS, WNC-3Y-208-MB
WNC-3Y-400-MB	Continental Control Systems LLC, WattNode MODBUS, WNC-3Y-400-MB
WNC-3Y-480-MB	Continental Control Systems LLC, WattNode MODBUS, WNC-3Y-480-MB
WNC-3Y-600-MB	Continental Control Systems LLC, WattNode MODBUS, WNC-3Y-600-MB
WNC-3D-240-MB	Continental Control Systems LLC, WattNode MODBUS, WNC-3D-240-MB
WNC-3D-400-MB	Continental Control Systems LLC, WattNode MODBUS, WNC-3D-400-MB
WNC-3D-480-MB	Continental Control Systems LLC, WattNode MODBUS, WNC-3D-480-MB

Table 8: Slave ID Additional Data Field Values

Modbus Register Lists

This section lists the Modbus registers. The following sections provide detailed information about each register. The registers are grouped as follows:

- **Basic Registers:** Floating Point
- **Basic Registers:** Integer
- **Advanced Registers:** Floating Point
- **Advanced Registers:** Integer
- **Configuration Registers:** Integer
- **Customer Diagnostic Registers:** Integer
- **Option Information Registers:** Integer
- **Custom Register Map**

Modbus Register Addressing

There are a few points about Modbus register addressing that can cause confusion.

- In the Modbus specification, register numbers are documented as "one based", but transmitted as "zero based". For example, we document that *EnergySum* appears at address **1001**. If you are using any Modbus software or Modbus aware device, you should use "1001" as the register address. However, if you are writing your own low-level Modbus driver or firmware, you will need to subtract one from the register number when creating the Modbus frame (or

packet), so the actual register number that appears on the RS-485 bus will be “1000” (or in hexadecimal, 0x03E8).

- A common Modbus convention adds the function code as a leading digit on the register number, so a register like **EnergySum (1001)** would be documented as **41001**. All input registers (function code 04) would use the form **4xxxx**, while holding registers (function code 03) would use the form **3xxxx**. The WattNode meter treats holding registers and input registers interchangeably, and does not use this convention. If your Modbus software expects a leading “3” or “4”, either will work for most registers, and use “3” for configuration registers.

Floating Point and Integer Registers

Most registers are available in floating point and integer formats. We generally recommend using the floating point registers, because they provide more resolution and dynamic range and they never requiring scaling. However, for energy variables, the 32 bit integer registers may be a better choice, because they provide a constant resolution of 0.1 kWh. Since most of the integer registers are 16 bits, they are faster to transfer over the Modbus interface and may require less space if they are being logged.

Most of the integer registers are 16 bit signed integers that can report positive or negative values from -32,768 to +32,767. In a few special cases, such as the energy registers, we use 32 bit signed integer registers (sometimes called “long integer”), which use two adjacent Modbus registers and can report values up to approximately \pm two billion.

Floating point values can report positive or negative values with typically six or seven significant digits, which is far higher than the WattNode meter’s accuracy. However, for energy measurements (kWh), floating point values have a limitation: the effective resolution in kWh gets lower as more energy accumulates. If the total energy exceeds 100,000 kWh, the resolution of the floating point energy will become coarser than 0.1 kWh, the constant resolution of the integer energy values. At a total energy of 1,000,000 kWh, the floating point energy resolution becomes 1.0 kWh.

Reading and Writing 32 Bit Registers

Since floating point and 32 bit long integer registers require two adjacent registers to store 32 bits, there are some things to note when reading and writing these 32 bit dual registers:

- The first register (at the lower address) contains the least significant 16 bits of data. This is called little-endian and is the default for many programs that read 32 bit Modbus values, but if this results in bizarre values (very large, very small, strange exponents, invalid values), look for an option to reverse the registers, commonly referred to as “Float - Swapped”, “Float - Reversed”, “Long - Swapped”, etc. Tridium JACE® systems refer to this as “byte order 1032”. Do not select 64 bit double precision formats.
- When reading a 32 bit register, read both registers with a single Modbus read command. The WattNode meter is guaranteed to return consistent results for a single multiple register read command. If you (or your software) issues two separate read commands for the two registers making up a 32 bit register, the underlying 32 bit register may be updated between the two read commands, resulting in an inconsistent or scrambled value.
- When writing to 32 bit registers, the recommended approach is to use the **Write Multiple Registers (16)** command to update both registers at the same time. However, meter incorporates logic to allow two **Write Single Register (06)** commands within 30 seconds, provided no other Modbus commands are issued between the two writes.

For more information on Modbus register formats, floating point, programming, etc., see http://www.ccontrols.com/w/Category:WattNode_Modbus.

Basic Register List - Floating Point

The following registers provide the most commonly used measurements in floating point units. See [Basic Registers \(p. 40\)](#) below for detailed information.

Registers	Name	Units	Description
Energy Registers			
1001, 1002	EnergySum**	kWh	Total net (bidirectional) energy
1003, 1004	EnergyPosSum**	kWh	Total positive energy
1005, 1006	EnergySumNR*	kWh	Total net (bidirectional) energy - non-resettable
1007, 1008	EnergyPosSumNR*	kWh	Total positive energy - non-resettable
Power Registers			
1009, 1010	PowerSum	W	Real power, sum of active phases
1011, 1012	PowerA	W	Real power, phase A
1013, 1014	PowerB	W	Real power, phase B
1015, 1016	PowerC	W	Real power, phase C
Voltage Registers			
1017, 1018	VoltAvgLN	V	Average line-to-neutral voltage
1019, 1020	VoltA	V	RMS voltage, phase A to neutral
1021, 1022	VoltB	V	RMS voltage, phase B to neutral
1023, 1024	VoltC	V	RMS voltage, phase C to neutral
1025, 1026	VoltAvgLL	V	Average line-to-line voltage
1027, 1028	VoltAB	V	RMS voltage, line-to-line, phase A to B
1029, 1030	VoltBC	V	RMS voltage, line-to-line, phase B to C
1031, 1032	VoltAC	V	RMS voltage, line-to-line, phase A to C
Frequency Register			
1033, 1034	Freq	Hz	Power line frequency

*These registers are preserved across power failures.

†These registers support resetting or presetting the value.

Basic Register List - Integer

The following registers provide the most commonly used measurements in integer units. The energy registers are 32 bit signed integer values, which require two registers, the first register provides the lower 16 bits, and the second register provides the upper 16 bits of the 32 bit value. See [Basic Registers \(p. 40\)](#) below for detailed information.

Registers	Name	Units	Description
Energy Registers			
1201, 1202	EnergySum**	0.1 kWh	Total net (bidirectional) energy
1203, 1204	EnergyPosSum**	0.1 kWh	Total positive energy
1205, 1206	EnergySumNR*	0.1 kWh	Total net (bidirectional) energy - non-resettable
1207, 1208	EnergyPosSumNR*	0.1 kWh	Total positive energy - non-resettable
Power Registers			
1209	PowerSum	PowerIntScale	Real power, sum of active phases
1210	PowerA	PowerIntScale	Real power, phase A
1211	PowerB	PowerIntScale	Real power, phase B
1212	PowerC	PowerIntScale	Real power, phase C

Registers	Name	Units	Description
Voltage Registers			
1213	VoltAvgLN	0.1 V	Average line-to-neutral voltage
1214	VoltA	0.1 V	RMS voltage, phase A to neutral
1215	VoltB	0.1 V	RMS voltage, phase B to neutral
1216	VoltC	0.1 V	RMS voltage, phase C to neutral
1217	VoltAvgLL	0.1 V	Average line-to-line voltage
1218	VoltAB	0.1 V	RMS voltage, line-to-line, phase A to B
1219	VoltBC	0.1 V	RMS voltage, line-to-line, phase B to C
1220	VoltAC	0.1 V	RMS voltage, line-to-line, phase A to C

Frequency Register

1221	Freq	0.1 Hz	Power line frequency
------	------	--------	----------------------

*These registers are preserved across power failures.

†These registers support resetting or presetting the value.

Advanced Register List - Floating Point

The following registers provide more advanced measurements in floating point units. See **Advanced Registers (p. 41)** below for detailed information. Note: the advanced registers **IoPinState** and **PulseCount** only appear in the **Advanced Register List - Integer**.

Registers	Name	Units	Description
Energy Registers			
1101, 1102	EnergyA*†	kWh	Net (bidirectional) energy, phase A
1103, 1104	EnergyB*†	kWh	Net (bidirectional) energy, phase B
1105, 1106	EnergyC*†	kWh	Net (bidirectional) energy, phase C
1107, 1108	EnergyPosA*†	kWh	Positive energy, phase A
1109, 1110	EnergyPosB*†	kWh	Positive energy, phase B
1111, 1112	EnergyPosC*†	kWh	Positive energy, phase C
1113, 1114	EnergyNegSum*†	kWh	Negative energy, sum of active phases
1115, 1116	EnergyNegSumNR*	kWh	Negative energy, sum of active phases - non-resettable
1117, 1118	EnergyNegA*†	kWh	Negative energy, phase A
1119, 1120	EnergyNegB*†	kWh	Negative energy, phase B
1121, 1122	EnergyNegC*†	kWh	Negative energy, phase C
1123, 1124	EnergyReacSum*†	kVARh	Reactive energy, sum of active phases
1125, 1126	EnergyReacA*†	kVARh	Net reactive energy, phase A
1127, 1128	EnergyReacB*†	kVARh	Net reactive energy, phase B
1129, 1130	EnergyReacC*†	kVARh	Net reactive energy, phase C
1131, 1132	EnergyAppSum*†	kVAh	Apparent energy, sum of active phases
1133, 1134	EnergyAppA*†	kVAh	Apparent energy, phase A
1135, 1136	EnergyAppB*†	kVAh	Apparent energy, phase B
1137, 1138	EnergyAppC*†	kVAh	Apparent energy, phase C

Power Factor Registers

1139, 1140	PowerFactorAvg		Power factor, average
1141, 1142	PowerFactorA		Power factor, phase A
1143, 1144	PowerFactorB		Power factor, phase B
1145, 1146	PowerFactorC		Power factor, phase C

Registers	Name	Units	Description
Reactive and Apparent Power Registers			
1147, 1148	PowerReacSum	VAR	Reactive power, sum of active phases
1149, 1150	PowerReacA	VAR	Reactive power, phase A
1151, 1152	PowerReacB	VAR	Reactive power, phase B
1153, 1154	PowerReacC	VAR	Reactive power, phase C
1155, 1156	PowerAppSum	VA	Apparent power, sum of active phases
1157, 1158	PowerAppA	VA	Apparent power, phase A
1159, 1160	PowerAppB	VA	Apparent power, phase B
1161, 1162	PowerAppC	VA	Apparent power, phase C
Current Registers			
1163, 1164	CurrentA	A	RMS current, phase A
1165, 1166	CurrentB	A	RMS current, phase B
1167, 1168	CurrentC	A	RMS current, phase C
Demand Registers			
1169, 1170	Demand	W	Real power demand averaged over the demand period
1171, 1172	DemandMin*	W	Minimum power demand
1173, 1174	DemandMax*	W	Maximum power demand
1175, 1176	DemandApp	W	Apparent power demand
1177, 1178	DemandA	W	Real power demand, phase A
1179, 1180	DemandB	W	Real power demand, phase B
1181, 1182	DemandC	W	Real power demand, phase C

*These registers are preserved across power failures.

†These registers support resetting or presetting the value.

Advanced Register List - Integer

These registers provide advanced integer measurements. The energy registers are 32 bit signed dual registers: the first register provides the lower 16 bits, and the second register provides the upper 16 bits of the 32 bit value. See [Advanced Registers \(p. 41\)](#) below for detailed information.

Registers	Name	Units	Description
Energy Registers			
1301, 1302	EnergyA [†]	0.1 kWh	Net energy, phase A
1303, 1304	EnergyB [†]	0.1 kWh	Net energy, phase B
1305, 1306	EnergyC [†]	0.1 kWh	Net energy, phase C
1307, 1308	EnergyPosA [†]	0.1 kWh	Positive energy, phase A
1309, 1310	EnergyPosB [†]	0.1 kWh	Positive energy, phase B
1311, 1312	EnergyPosC [†]	0.1 kWh	Positive energy, phase C
1313, 1314	EnergyNegSum ^{*†}	0.1 kWh	Negative energy, sum of active phases
1315, 1316	EnergyNegSumNR [*]	0.1 kWh	Negative energy, sum of active phases - non-resettable
1317, 1318	EnergyNegA [†]	0.1 kWh	Negative energy, phase A
1319, 1320	EnergyNegB [†]	0.1 kWh	Negative energy, phase B
1321, 1322	EnergyNegC [†]	0.1 kWh	Negative energy, phase C
1323, 1324	EnergyReacSum ^{*†}	0.1 kVARh	Reactive energy, sum of active phases
1325, 1326	EnergyReacA [†]	0.1 kVARh	Net reactive energy, phase A
1327, 1328	EnergyReacB [†]	0.1 kVARh	Net reactive energy, phase B
1329, 1330	EnergyReacC [†]	0.1 kVARh	Net reactive energy, phase C
1331, 1332	EnergyAppSum ^{*†}	0.1 kVAh	Apparent energy, sum of active phases
1333, 1334	EnergyAppA [†]	0.1 kVAh	Apparent energy, phase A

Registers	Name	Units	Description
1335, 1336	EnergyAppB*†	0.1 kVAh	Apparent energy, phase B
1337, 1338	EnergyAppC*†	0.1 kVAh	Apparent energy, phase C

Power Factor Registers

1339	PowerFactorAvg	0.01	Power factor, average
1340	PowerFactorA	0.01	Power factor, phase A
1341	PowerFactorB	0.01	Power factor, phase B
1342	PowerFactorC	0.01	Power factor, phase C

Reactive and Apparent Power Registers

1343	PowerReacSum	PowerIntScale	Reactive power VAR, sum of active phases
1344	PowerReacA	PowerIntScale	Reactive power VAR, phase A
1345	PowerReacB	PowerIntScale	Reactive power VAR, phase B
1346	PowerReacC	PowerIntScale	Reactive power VAR, phase C
1347	PowerAppSum	PowerIntScale	Apparent power VA, sum of active phases
1348	PowerAppA	PowerIntScale	Apparent power VA, phase A
1349	PowerAppB	PowerIntScale	Apparent power VA, phase B
1350	PowerAppC	PowerIntScale	Apparent power VA, phase C

Current Registers

1351	CurrentA	CurrentIntScale	RMS current, phase A
1352	CurrentB	CurrentIntScale	RMS current, phase B
1353	CurrentC	CurrentIntScale	RMS current, phase C

Demand Registers

1354	Demand	PowerIntScale	Real power demand averaged over the demand period
1355	DemandMin*	PowerIntScale	Minimum power demand
1356	DemandMax*	PowerIntScale	Maximum power demand
1357	DemandApp	PowerIntScale	Apparent power demand
1358	DemandA	PowerIntScale	Real power demand, phase A
1359	DemandB	PowerIntScale	Real power demand, phase B
1360	DemandC	PowerIntScale	Real power demand, phase C
1361	IoPinState		I/O pin digital input or output state
1362	PulseCount		I/O pin pulse count

*These registers are preserved across power failures.

†These registers support resetting or presetting the value.

Configuration Register List

These integer registers configure and customize the WattNode Modbus meter. For simple installations, only **CtAmps** needs to be set. By default, there is no passcode for the configuration, but if security is required, a passcode can be assigned. The configuration registers are all integer format. See the section **Configuration Registers (p. 46)** below for detailed information.

Registers	Name	Units	Default	Description
1601, 1602	<u>ConfigPasscode</u>		0	Optional passcode to prevent unauthorized changes to configuration
1603	<u>CtAmps</u>	1 A	5	Assign global current transformer rated current
1604	<u>CtAmpsA*</u>	1 A	5	ϕA CT rated current (0 to 6000)
1605	<u>CtAmpsB*</u>	1 A	5	ϕB CT rated current (0 to 6000)
1606	<u>CtAmpsC*</u>	1 A	5	ϕC CT rated current (0 to 6000)
1607	<u>CtDirections*</u>		0	Optionally invert CT orientations (0 to 7)
1608	<u>Averaging*</u>		1 (fast)	Configure measurement averaging (0 to 3)
1609	<u>PowerIntScale*</u>	1 W	0 (auto)	Scaling for integer power registers (0 to 1000)

Registers	Name	Units	Default	Description
1610	<u>DemPerMins</u> *	1 minute	15	Demand period (1 to 720)
1611	<u>DemSubints</u> *		1	Number of demand subintervals (1 to 10)
1612	<u>GainAdjustA</u> *	1/10000th	10000	ϕ A power/energy adjustment (5000 to 20000)
1613	<u>GainAdjustB</u> *	1/10000th	10000	ϕ B power/energy adjustment (5000 to 20000)
1614	<u>GainAdjustC</u> *	1/10000th	10000	ϕ C power/energy adjustment (5000 to 20000)
1615	<u>PhaseAdjustA</u> *	0.001 deg	-1000	ϕ A CT phase angle adjust (-8000 to 8000)
1616	<u>PhaseAdjustB</u> *	0.001 deg	-1000	ϕ B CT phase angle adjust (-8000 to 8000)
1617	<u>PhaseAdjustC</u> *	0.001 deg	-1000	ϕ C CT phase angle adjust (-8000 to 8000)
1618	<u>CreepLimit</u> *		1500	Minimum power for readings (100 to 10000)
1619	<u>PhaseOffset</u> *	1 degree	120	Nominal angle between primary voltage phases (0, 60, 90, 120 or 180)
1620	<u>ZeroEnergy</u>		0	Write 1 to zero all resettable energy registers
1621	<u>ZeroDemand</u>		0	Write 1 to zero all demand values
1622	<u>CurrentIntScale</u> *		20000	Scale factor for integer currents (0 to 32767)
1623	<u>IoPinMode</u> *		varies	I/O pin mode for Option IO or SSR (0 to 8)

*These registers are preserved across power failures.

Communication Register List

These integer registers can be used to override the DIP switch address and baud rate settings and for more advanced communication settings, like even parity or 38,400 baud. See **Communication Registers (p. 50)** below for details.

Registers	Name	Default	Description
1651	<u>ApplyComConfig</u>	0	Writing 1234 applies the configuration settings below. Reads 1 if changes not applied yet.
1652	<u>Address</u> *	0	Modbus address (if non-zero, overrides DIP switches)
1653	<u>BaudRate</u> *	0	0 = DIP Switch Assigned, 1 = 1200 baud, 2 = 2400 baud, 3 = 4800 baud, 4 = 9600 baud, 5 = 19200 baud, 6 = 38400 baud
1654	<u>ParityMode</u> *	0	0 = N81 (no parity, one stop bit) 1 = E81 (even parity, one stop bit)
1655	<u>ModbusMode</u> *	0	0=RTU 1=TCP-RTU
1656	<u>ReplyDelay</u> *	5	Minimum Modbus reply delay: 5 to 180 ms

*These registers are preserved across power failures.

Diagnostic Register List

These registers provide information and diagnostics for the meter. These are all integer registers. **UptimeSecs** and **TotalSecs** are 32 bit integer dual registers: the first register provides the lower 16 bits, and the second register provides the upper 16 bits of the 32 bit value. See **Diagnostic Registers (p. 51)** and **Error Codes (p. 52)** below for detailed information.

Registers	Name	Units	Description
0001, 0002	Dummy		Dummy register; always returns zero; can be used to scan for active Modbus devices
1701, 1702	<u>SerialNumber</u> *		The WattNode meter serial number
1703, 1704	<u>UptimeSecs</u>	Seconds	Time in seconds since last power on
1705, 1706	<u>TotalSecs</u> *	Seconds	Total seconds of operation
1707	<u>Model</u> *		Encoded WattNode model
1708	<u>Version</u> *		Firmware version
1709	<u>Options</u> *		WattNode meter options
1710	<u>ErrorStatus</u> *	n.a.	List of recent errors and events
1711	<u>PowerFailCount</u> *		Power failure count

Registers	Name	Units	Description
1712	CrcErrorCount		Count of Modbus CRC communication errors
1713	FrameErrorCount		Count of Modbus framing errors
1714	PacketErrorCount		Count of bad Modbus packets
1715	OverrunCount		Count of Modbus buffer overruns
1716	ErrorStatus1	n.a.	Newest error or event (0 = no errors)
1717	ErrorStatus2	n.a.	Next oldest error or event
1718	ErrorStatus3	n.a.	Next oldest error or event
1719	ErrorStatus4	n.a.	Next oldest error or event
1720	ErrorStatus5	n.a.	Next oldest error or event
1721	ErrorStatus6	n.a.	Next oldest error or event
1722	ErrorStatus7	n.a.	Next oldest error or event
1723	ErrorStatus8	n.a.	Oldest error or event

*These registers are preserved across power failures.

Option Information Registers

These registers document options ordered with the meter. They are read-only, but all options with an “Override Register) may be overridden in the field (such as the **CtAmpsA**). These registers will always show the original option value. If an option hasn’t been specified, the value will be zero.

For details, see http://www.ccontrols.com/w/WattNode_Modbus_Option_Identification.

Registers	Name	Override Register	Description
1724	OptCtAmpsA	CtAmpsA	Option CT - phase A CtAmps
1725	OptCtAmpsB	CtAmpsB	Option CT - phase B CtAmps
1726	OptCtAmpsC	CtAmpsC	Option CT - phase C CtAmps
1727	OptModbusMode	ModbusMode	Option TCP-RTU for Modbus protocol
1728	OptAddress	Address	Option AD - Modbus address
1729	OptBaudRate	BaudRate	Option 19K or 38K - baud rate
1730	OptParityMode	ParityMode	Option EP - even parity
1731	Opt232	n.a.	Option 232 - RS-232 interface installed
1732	OptTTL	n.a.	Option TTL - TTL interface installed
1733	OptIO	n.a.	Option IO - Digital I/O and pulse counter
1734	OptX5	n.a.	Option X5 - 5 Vdc @ 60 mA power output
1735	OptSSR	n.a.	Option SSR - Solid-state relay output
1736	OptIoPinMode	IoPinMode	Option value for IoPinMode register

Custom Register Map

The WattNode Modbus meter offers the ability to remap the register addresses (starting with firmware version 16) to allow the following:

- Combine a custom set of registers into a contiguous range, which can be read with a single Modbus read command. This can be much more efficient than reading two or more discontinuous sets of registers, especially if you are monitoring many meters on a single Modbus subnet.
- Emulate another device by reorganizing the WattNode Modbus meter registers.
- Swap the most and least significant words of 32 bit registers (used for floating point and integer energy values) for compatibility with Modbus master software that expects a different register order.

For details, see http://www.ccontrols.com/w/WattNode_Modbus_Custom_Register_Map.

Basic Registers

Energy Registers

Commonly known as kWh (kilowatt-hours), the energy is the integral of power over time. Many installations will only use the energy measurement. It is commonly used for billing or sub-metering. Because energy is an accumulated value, it can be used on networks that are accessed infrequently (like a utility meter that only needs to be read once a month). All energy register values are preserved through power failures.

In the WattNode Modbus meter, most energy registers can be reset to zero by writing “1” to the **ZeroEnergy** register. They can also be set to zero or a preset value by writing the desired value directly to each register. All energy registers ending with “NR” (for non-resetting) cannot be reset to zero for billing security. You can protect all energy registers from being zeroed or preset by setting a **ConfigPasscode**.

All energy registers wrap around to zero when they reach 100 gigawatt-hours (100 x 10⁹ watt-hours) or negative 100 gigawatt-hours (only some energy registers allow negative values).

During a power outage, the energy consumed will not be measured. Whenever the line voltage drops below 60–80% of nominal, the meter will shut down until power is restored. To preserve the energy measurement across power outages, the meter writes the energy to non-volatile (ferroelectric RAM) memory every second. When power returns, the last stored value is recovered.

EnergySum, EnergySumNR

EnergySum is the net real energy sum of all active phases, where “net” means negative energy will subtract from the total. This value is appropriate for net metering applications (i.e. photovoltaic) where you wish to measure the net energy in situations where you may sometimes consume energy and other times generate energy. Use **EnergyPosSum** instead if you don’t want negative energy to subtract from the total.

EnergySum is reset to zero when “1” is written to the **ZeroEnergy** register.

The **EnergySumNR** is identical to **EnergySum** except that it cannot be reset to zero.

EnergyPosSum, EnergyPosSumNR

EnergyPosSum is equivalent to a traditional utility meter that can only spin in one direction. Every second, the measured real energies for each active phase are added together. If the result is positive, it is added to **EnergyPosSum**. If it is negative, then **EnergyPosSum** is left unchanged.

EnergyPosSum is reset to zero when “1” is written to the **ZeroEnergy** register.

The **EnergySumPosNR** is identical to **EnergySumPos** except that it cannot be reset to zero.

Power Registers

PowerA, PowerB, PowerC

The WattNode meter measures real power (watts) for each phase (**PowerA, PowerB, PowerC**). The measured power is generally positive, but may also be negative, either because you are generating power (such as with solar panels), or because the meter isn’t connected properly.

The integer power registers are scaled by **PowerIntScale** to prevent overflow. The integer power registers can only report values from -32767 to +32767. To allow for large power values, **PowerIntScale** acts as a multiplier to multiply by 1, 10, 100, or 1000. See **Configuration Registers (p. 46)** for details. To scale the integer **PowerA, PowerB, PowerC**, or **PowerSum** to watts, use the following equation:

$$Power(W) = PowerSum \cdot PowerIntScale$$

For example, if **PowerIntScale (1609)** is 100, and the integer **PowerSum (1209)** reports 2500, then the power sum is 2500 * 100 = 250,000 W (or 250 kW).

PowerSum

This is the sum of the real power for active phases (line voltage above 20% of nominal). This can include negative values, so if one phase is negative, it will reduce the reported ***PowerSum***.

Voltage Registers

All integer voltage registers are reported in units of 0.1 VAC, so 1234 = 123.4 VAC.

VoltAvgLN

This is the average line-to-neutral voltage (average of ***VoltA***, ***VoltB***, and ***VoltC***). Only active phases are included (phases where the voltage is above 20% of nominal).

VoltA, VoltB, VoltC

These are the RMS AC voltages for each phase, measured relative to the neutral connection on the meter. If neutral is not connected, then they are measured relative to the ground connection.

Voltage phases that are not connected may report small random voltages, but the WattNode meter treats any phase reporting less than 20% of the nominal VAC as inactive and will not measure power or energy on inactive phases.

VoltAvgLL

This is the average line-to-line voltage (average of ***VoltAB***, ***VoltBC***, and ***VoltAC***). All phases are included in the average.

VoltAB, VoltBC, VoltAC

The WattNode meter cannot directly measure line-to-line voltages. It provides these registers as estimates of the line-to-line voltage. In order to estimate these voltages, the meter must know the phase offset or the type of electrical service (see ***PhaseOffset*** configuration register).

Frequency

Freq

The WattNode meter measures the AC line frequency in Hertz. The integer ***Freq*** register reports the frequency in units of 0.1 Hz. All phases must have the same line frequency; otherwise this value will be erratic or incorrect.

Advanced Registers

Per-Phase Energy Registers

EnergyA, EnergyB, EnergyC

The per-phase energy registers report the net real energy for each phase, where “net” means negative energy will subtract from the total. This value is appropriate for net metering applications (i.e. photovoltaic) where you wish to measure the net energy in situations where you may sometimes consume energy and other times generate energy.

These values are reset to zero when “1” is written to the ***ZeroEnergy*** register. You may also reset them to zero or load preset values by writing to these registers.

Positive Energy

EnergyPosA, EnergyPosB, EnergyPosC

The per-phase positive energy registers measure the positive real energy for each phase. Negative energy is ignored (instead of subtracting from the total). Energy is measured once per second, so the determination of whether the energy is positive is based on the overall energy for the second.

These values are reset to zero when “1” is written to the **ZeroEnergy** register. You may also reset them to zero or load preset values by writing to these registers.

Negative Energy

The negative energy registers are exactly like the positive energy registers except they accumulate negative energy. The reported energy values will be positive. In other words, if the WattNode measures 1000 kWh of negative energy, **EnergyNegSum** will report 1000 (not -1000).

The negative energy registers are reset to zero (except for **EnergySumNegNR**) when “1” is written to the **ZeroEnergy** register. You may also reset them to zero or load preset values (except for **EnergySumNegNR**) by writing to these registers.

EnergyNegSum

Every second, the measured real energies for each active phase are added together. If the result is negative, it is added to **EnergyNegSum**. If it is positive, then **EnergyNegSum** is left unchanged.

EnergyNegSumNR

The **EnergySumNegNR** is identical to **EnergyNegPos** except that it cannot be reset to zero.

EnergyNegA, EnergyNegB, EnergyNegC

These are the per-phase negative real energy registers.

Reactive Energy

EnergyReacSum, EnergyReacA, EnergyReacB, EnergyReacC

Reactive energy is also known as kVAR-hours. Inductive loads, like motors, generate positive reactive power and energy, while capacitive loads generate negative reactive energy. These are all bidirectional registers that can count up or down depending on the sign of the reactive power.

The WattNode meter only measures the fundamental reactive energy, not including harmonics.

These values are reset to zero when “1” is written to the **ZeroEnergy** register. You may also reset them to zero or load preset values by writing to these registers.

Apparent Energy

EnergyAppSum, EnergyAppA, EnergyAppB, EnergyAppC

Apparent energy (kVA-hours) is the accumulation of apparent power over time. The apparent power is essentially the RMS voltage multiplied by the RMS current for each phase. For example, if you have 120 VAC RMS, 10 amps RMS, one phase, the apparent power will be 1200 VA. At the end of an hour, the apparent energy will be 1.2 kVA-hour. Apparent energy is always positive.

The WattNode meter’s apparent energy includes real harmonics, but not reactive harmonics.

These values are reset to zero when “1” is written to the **ZeroEnergy** register. You may also reset them to zero or load preset values by writing to these registers.

Power Factor

The power factor is the ratio of the real power to the apparent power. Resistive loads, like incandescent lighting and electric heaters, should have a power factor near 1.0. Power-factor corrected loads, like computers, should be near 1.0. Motors can have power factors from 0.2 to 0.9, but are commonly in the 0.5 to 0.7 range.

If the power for a phase is negative, the power factor will also be negative. The reported power factor will be 1.0 for any phases measuring zero power, and will be 0.0 for any inactive phases (line voltage below 20% of nominal VAC).

The WattNode meter measures the displacement or fundamental power factor, which does not include harmonics.

Integer power factor registers are reported in units of 0.01, so 85 equals a power factor of 0.85.

PowerFactorA, PowerFactorB, PowerFactorC

These are the power factor values for each phase.

PowerFactorAvg

This is the average power factor, computed as ***PowerSum / ApparentPowerSum***.

Reactive Power

Reactive power is also known as VARs. Inductive loads, like motors, generate positive reactive power, while capacitive loads generate negative reactive power. Reactive power transfers no net energy to the load and generally is not metered by the utility. Loads with high reactive power relative to the real power will tend to have lower power factors. The integer reactive power registers are scaled by ***PowerIntScale***.

The WattNode meter only measures the fundamental reactive power, not including harmonics.

To scale the integer ***PowerReacA, PowerReacB, PowerReacC, or PowerReacSum*** to VARs, use the following equation:

$$\text{PowerReac(VAR)} = \text{PowerReacSum} \cdot \text{PowerIntScale}$$

For example, if ***PowerIntScale (1609)*** is 100, and the integer ***PowerReacSum (1343)*** reports 1500, then the reactive power sum is $1500 * 100 = 150,000$ VAR (or 150 kVAR).

PowerReacA, PowerReacB, PowerReacC

These are the per-phase reactive power measurements.

PowerReacSum

The ***PowerReacSum*** is the sum of the reactive power of active phases. This can include negative values, so if one phase is negative, it will reduce the reported ***PowerReacSum***.

Apparent Power

Apparent power (VA) can be described three ways:

- The RMS voltage multiplied by the RMS current.
- The square root of the real power squared plus the reactive power squared.
- The absolute value or magnitude of the complex power.

The WattNode meter's measurement of apparent power includes real, but not reactive harmonic apparent power content.

Apparent power is always a positive quantity. The integer apparent power registers are scaled by ***PowerIntScale***.

PowerAppA, PowerAppB, PowerAppC

These are the per-phase apparent power measurements.

PowerAppSum

The ***PowerAppSum*** is the sum of apparent power for active phases.

Current

The WattNode Modbus meter estimates the RMS current for each phase. This is an indirect measurement and does not include all harmonic content, so the current is not as accurate as the power and energy measurements.

CurrentA, CurrentB, CurrentC

Technically, AC current does not have a sign (positive or negative), but the WattNode meter sets the sign of the current to match the sign of the real power for the same phase. For example, if the power on phase A is negative, then the current for phase A (**CurrentA**) will also be negative.

The floating point current registers are in units of amps. The integer current registers are in scaled amps (**CurrentIntScale**, default value 20000), so the following equations will convert to amps.

$$I_a = \text{CurrentAInt} * \text{CtAmpsA} / \text{CurrentIntScale}$$

$$I_b = \text{CurrentBInt} * \text{CtAmpsB} / \text{CurrentIntScale}$$

$$I_c = \text{CurrentCInt} * \text{CtAmpsC} / \text{CurrentIntScale}$$

For example, with 200 amp current transformers and **CurrentIntScale** = 20000, if **CurrentAInt** (**1351**) reports 5000, the actual current is $5000 * 200 / 20000 = 50.00$ amps.

Demand

Demand is defined as the average power over a specified time interval. Typical demand intervals are 5, 10, 15 (default), 30, 60, etc. up to 720 minutes, but the WattNode meter supports arbitrary demand intervals from 1 to 720 minutes (12 hours). The meter records the peak demand for metering applications where the measurements may only be accessed weekly or monthly.

Since the WattNode meter can measure bidirectional power (positive and negative), and the demand is the average power over an interval, demand can also be positive or negative. This is only likely to occur with something like a grid-tied PV system, where you may put energy back into the grid at certain times of the day (negative power). In this case, you would see negative demand. If you have both positive and negative power during a demand interval, both the positive and the negative data will be averaged together, such that the negative power subtracts from the positive, reducing the overall demand.

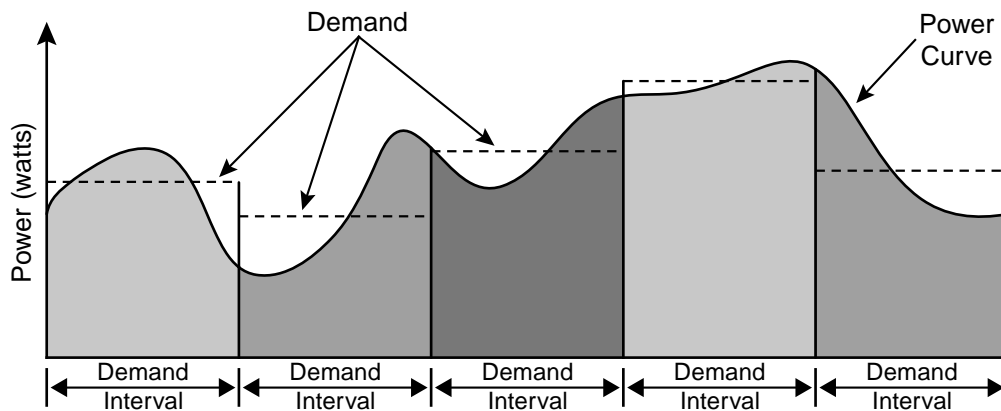

Figure 10: Demand Measurement

WattNode meters also supports rolling demand (also called “sliding window”), in which the demand intervals are evenly divided into a fixed number of subintervals. At the end of each subinterval, the average power over the demand interval is computed and output. This results in better accuracy, especially for demand peaks which would not have lined up with the demand interval without subintervals. On power up, the demand measurements will report zero until one full demand interval is completed. From 1 to 10 subintervals are supported. A subinterval count of

one (or zero) results in the standard demand measurement without rolling demand. See [Configuration Registers](#) for information on configuring the demand.

Any changes to the demand configuration ([DemPerMins](#), [DemSubints](#)) or CT configuration ([CtAmps](#), [CtAmpsA](#), [CtAmpsB](#), [CtAmpsC](#), [CtDirections](#)) will zero the reported demand and start a new demand measurement. The [DemandMin](#) and [DemandMax](#) will not be reset by configuration changes.

To manually zero some or all of the demand registers, see the [ZeroDemand](#) register in [Configuration Registers](#) below.

The floating point demand registers are reported in units of watts, while the integer demand registers must be scaled by [PowerIntScale](#) to compute watts. To scale the integer [Demand](#), [DemandA](#), [DemandB](#), [DemandC](#), [DemandMin](#), [DemandMax](#), or [DemandApp](#), use the following equation:

$$\text{Demand}(W) = \text{Demand} \cdot \text{PowerIntScale}$$

For example, if [PowerIntScale](#) (1609) is 100, and the integer [Demand](#) (1354) reports 4700, then the demand is $4700 \cdot 100 = 470,000$ watts (or 470 kW).

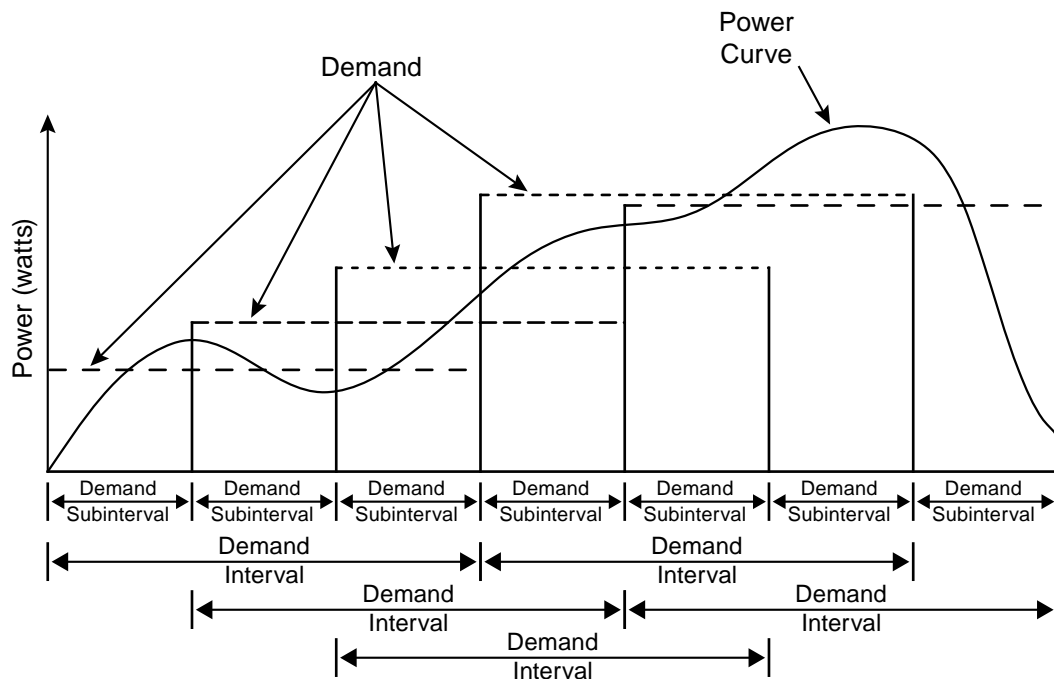

Figure 11: Rolling Demand with Three Subintervals

Demand

The [Demand](#) register is updated at the end of every subinterval with the average [PowerSum](#) over a full demand interval. After a power cycle or configuration change, [Demand](#) will report zero until the completion of one full demand interval.

DemandA, DemandB, DemandC

The real power demand is computed for each phase from [PowerA](#), [PowerB](#), and [PowerC](#).

DemandMin

The [DemandMin](#) is the smallest measured [Demand](#) (this may be negative for systems with power generation). It is preserved across power failures and can be reset with the [ZeroDemand](#)

register. Note: there are no minimum or maximum demand registers for **DemandA**, **DemandB**, and **DemandC**.

DemandMax

The **DemandMax** is the largest measured **Demand**. It is preserved across power failures and can be reset with the **ZeroDemand** register.

DemandApp

DemandApp is computed the same way as **Demand**, but using apparent power.

I/O Pin Options

IoPinState, PulseCount

For details about the I/O pin options registers and configuration, see the Continental Control Systems website: http://www.ccontrols.com/w/WattNode_Modbus_-_Option_IO.

Configuration Registers

ConfigPasscode (1601, 1602)

The WattNode Modbus meter has an optional configuration passcode to prevent unauthorized changes to the configuration. As shipped from the factory, the **ConfigPasscode** is set to "0", disabling the passcode. If a passcode is set, the meter must be unlocked by writing the correct value to **ConfigPasscode** before any configuration registers can be changed and before the energy or demand registers can be reset to zero.

You can read the **ConfigPasscode** register to determine if the meter is locked. You cannot read the actual passcode itself. If you lose your passcode, contact support for assistance.

- **0** - Unlocked
- **1** - Locked

Invalid unlock attempts will result in the Modbus exception 03 - "Illegal data value", and prevent more attempts for five seconds. An unlocked meter will become locked again after five minutes or when "1" is written twice to **ConfigPasscode**.

The passcode can be set (or changed) by writing the new passcode to **ConfigPasscode** twice within 30 seconds. If a passcode is already set, the meter must be unlocked first.

Valid passcode values are:

- 0 - this disables the passcode.
- 2 to 2,147,483,647 - use at least six digits for a secure passcode.

The passcode is a 32 bit value, so both register locations **1601** and **1602** must be written when unlocking the WattNode or setting a passcode.

CtAmps (1603)

Writing the **CtAmps** register is a shortcut to quickly set **CtAmpsA**, **CtAmpsB**, and **CtAmpsC** to the same value. If you read **CtAmps** and **CtAmpsA**, **CtAmpsB**, **CtAmpsC** are all identical, then **CtAmps** will return the common value; otherwise it will return 0 (zero) to indicate there is no common value.

CtAmpsA, CtAmpsB, CtAmpsC (1604 , 1605, 1606)

The CT amps registers are integer registers in units of amps used to set the rated current of the attached current transformers (CTs). This allows the use of different CTs on different input phases: **ΦA**, **ΦB**, and **ΦC**. Rated current is the 100% value; the current that results in a 0.33333 VAC output from the CT.

You can order the meter from the factory with the CtAmps preconfigured using **Option CT=xxx** or **Option CT=xxx/yyy/zzz** if there are different CTs on phases A, B, and C. For example, **Option CT=100/100/50** sets **CtAmpsA** = 100, **CtAmpsB** = 100, and **CtAmpsC** = 50.

The specified rated CT amps for each phase (**CtAmpsA**, **CtAmpsB**, and **CtAmpsC**), affect the scaling **CurrentIntScale** for the integer current registers **CurrentA**, **CurrentB**, and **CurrentC**. See section **Current (p. 44)** above for details.

CtDirections (1607)

On occasion, current transformers are installed with the label “This side towards source” facing the load instead of the source, or with the white and black wires swapped at the meter. If the electrical installer notices this, they can fix it, but sometimes the problem isn’t noticed until the electrician is gone and some or all of the reported power values are unexpectedly negative.

You can correct this with the **CtDirections** register:

- **0** - All CTs normal
- **1** - Flip phase A CT
- **2** - Flip phase B CT
- **4** - Flip phase C CT
- **3** - Flip phase A CT and flip phase B CT
- **5** - Flip phase A CT and flip phase C CT
- **6** - Flip phase B CT and flip phase C CT
- **7** - Flip all CTs (A, B, and C)

Flipping a CT with **CtDirections** will also reverse the status LED indications. So if the status LED for a phase was flashing red and you flip the CT with **CtDirections**, the LED will change to green flashing. This cannot be used to correct for situations where CT phases do not match the voltage phases, such as swapping phases A and B on the current transformer inputs.

Averaging (1608)

The WattNode includes averaging for these registers: **PowerSum**, **PowerA**, **PowerB**, **PowerC**, **VoltAvgLN**, **VoltA**, **VoltB**, **VoltC**, **VoltAvgLL**, **VoltAB**, **VoltBC**, **VoltAC**, **Freq**, **PowerFactorAvg**, **PowerFactorA**, **PowerFactorB**, **PowerFactorC**, **PowerReacSum**, **PowerReacA**, **PowerReacB**, **PowerReacC**, **PowerAppSum**, **PowerAppA**, **PowerAppB**, **PowerAppC**, **CurrentA**, **CurrentB**, **CurrentC**.

Averaging is beneficial because it reduces measurement noise, and if the WattNode is being polled less often than once a second (say once a minute), then the average over the last minute provides a more accurate reading than just the data from the last second, which might be randomly high or low. Averaging is configured by setting the **Averaging (1608)** register to one of the following values:

Averaging Register	Description	Averaging Period	Update Rate
0	Fastest	1 second	Every 1 second
1	Fast (default)	5 seconds	Every 1 second
2	Medium	20 seconds	Every 4 seconds
3	Slow	60 seconds	Every 12 seconds

Table 9: Averaging Settings

When medium or slow averaging are specified, the reported values for averaged registers will only update every 4 or 12 seconds respectively, instead of once a second.

PowerIntScale (1609)

In order to report power as an integer value ($\pm 32,767$), the meter must scale the power so that it doesn't overflow. By default, the WattNode meter selects a **PowerIntScale** value of 1, 10, 100, or 1000 whenever the **CtAmps** (or **CtAmpsA**, **CtAmpsB**, or **CtAmpsC**) are changed. The meter selects a value that won't overflow unless the power exceeds 120% of full-scale.

PowerIntScale	Power Resolution	Maximum Power Reading
0 (default)	Auto-configure	varies
1	1 watt	± 32767 W
10	10 watt	± 327.67 kW
100	100 watts	± 3276.7 kW
1000	1000 watts	± 32767 kW
Custom Values	PowerIntScale • 1 W	$\pm(\text{PowerIntScale} \cdot 32767$ W)

Table 10: PowerIntScale Settings

You may also choose your own custom value for **PowerIntScale** including values that are not multiples of 10.

If **PowerIntScale** is set to auto-configure, then reading **PowerIntScale** will show the actual scale factor instead of 0.

To compute the actual power from integer power registers, use the following equation (note, there is no scaling for the floating-point power registers, which always report power in watts):

$$\text{ActualPower}(W) = \text{PowerRegister} \cdot \text{PowerIntScale}$$

PowerIntScale is used with the following registers: **PowerSum**, **PowerA**, **PowerB**, **PowerC**, **PowerReacSum**, **PowerReacA**, **PowerReacB**, **PowerReacC**, **PowerAppSum**, **PowerAppA**, **PowerAppB**, **PowerAppC**, **Demand**, **DemandMin**, **DemandMax**, **DemandApp**.

CurrentIntScale (1622)

When reporting current values as integers, the WattNode meter scales the current values so that a current equal to the CT rated amps will result in an output value of **CurrentIntScale**. The default **CurrentIntScale** is 20000. See **CurrentA**, **CurrentB**, **CurrentC** for more details.

Demand Configuration

DemPerMins, DemSubints (1610, 1611)

The variable **DemPerMins** sets the demand interval in minutes (default 15 minutes), and **DemSubints** sets the number of demand intervals (default 1). The time period of each subinterval is the demand interval divided by the number of subintervals. Setting **DemSubints** to 1 disables subinterval computations. The demand period cannot be longer than 12 hours (720 minutes), and a demand subinterval cannot be less than 1 minutes. The **DemSubints** can be set from 1 to 10.

An example configuration could use a demand period of 60 minutes with 4 subintervals. This would result in a subinterval period of fifteen minutes. Every fifteen minutes, the average power over the last hour would be computed and reported.

GainAdjustA, GainAdjustB, GainAdjustC (1612, 1613, 1614)

You may need to adjust the WattNode meter to match the results from a reference meter (such as the utility meter) or to correct for known current transformer errors. The **GainAdjust** registers effectively adjust the power, energy, and current calibration or registration for each phase.

The default values for the **GainAdjust** registers are 10,000, resulting in no adjustment. Setting the value to 10,200 increases all the power, energy, and current readings from the meter by 2% ($10,200 / 10,000 = 102\%$). Setting the value to 9,800 decreases the readings by 2% ($9,800 / 10,000 = 98\%$). The allowed range is from 5,000 to 20,000 (50% to 200%).

PhaseAdjustA, PhaseAdjustB, PhaseAdjustC (1615, 1616, 1617)

For maximum accuracy, there may be cases where you wish to compensate for the phase angle error of the current transformers you are using. The **PhaseAdjust** registers allow the phase angle to be adjusted on each phase by up to ± 8 degrees in increments of one millidegree. For example, if your CT causes a phase lead of 0.6 degrees (or 36 minutes), you could correct for this by setting **PhaseAdjustA, B,** and **C** to -600, which subtracts 600 millidegree or 0.6 degree from the phase lead. Use negative values to compensate for a phase lead in the CT (most common). The default adjustment is 0.

CreepLimit (1618)

Creep refers to the situation where the wheel on an traditional electro-mechanical energy meter moves even though there is no power being consumed. The WattNode meter has no wheel, but all electrical systems have some noise, which can cause small readings in the absence of any power consumption. To prevent readings due to noise, if the readings fall below the creep limit, the meter forces the real and reactive power values to zero, and stops accumulating energy. This is performed independently for each measurement phase using the following equation.

$$\text{MinimumPower} = \text{FullScalePower} / \text{CreepLimit}$$

Any measured power or reactive power below *MinimumPower* is forced to zero. *FullScalePower* is defined as the nominal line-to-neutral VAC (see **Specifications - Models (p. 55)**) multiplied by the full-scale or rated CT current.

Generally, the default value of 1500 (which sets the creep limit to 1/1500th of full-scale power) works well. Sometime, in electrically noisy environments, you may see non-zero power readings when the power should be zero. You can adjust the creep limit to eliminate this problem. For example, to adjust the creep limit to 1/500th of full-scale (0.2%), set **CreepLimit** to 500.

PhaseOffset (1619)

The WattNode meter cannot directly measure line-to-line voltages (**VoltAB, VoltBC, VoltAC, VoltAvgLL**). To estimate these voltages, the meter must know the phase offset of the electrical service being measured. This setting has no effect on any other measurements or registers and is only needed if you plan to monitor the line-to-line voltages.

PhaseOffset (degrees)	Electrical Service Type
0	Single-phase (all line-to-line voltages will read zero). Use this setting when monitoring multiple independent branch circuits.
60	Three-phase grounded delta (grounded leg), where one phase is connected to earth (rare)
90	Four-wire delta (wild leg): 120/208/240
120 (default)	Three-phase: 120/208, 230/400, 277/480, 347/600
180	Single-phase three-wire (mid-point neutral): 120/240 VoltAB will report the line-to-line voltage. VoltBC and VoltAC will report zero regardless of the actual phase C voltage.

Table 11: PhaseOffset Values

Zeroing Registers

ZeroEnergy (1620)

Writing 1 to **ZeroEnergy** will simultaneously set all of the energy registers to zero, except those ending in "NR" (for non-resettable). They can also be set to zero or a preset value by writing the desired value directly to each energy register. If a **ConfigPasscode** has been set, then you must unlock the meter before you can zero or preset the energy.

As a security measure, there are three non-resettable energy registers—**EnergySumNR**, **EnergyPosSumNR**, **EnergyNegSumNR**—that can never be reset to zero.

ZeroDemand (1621)

The **ZeroDemand** register can be written with three values (or zero which does nothing). If a **ConfigPasscode** has been set, then you must unlock the meter before you can zero demand.

- **1** - Zero **DemandMin** and **DemandMax** registers.
- **2** - Zero **Demand**, **DemandA**, **DemandB**, **DemandC** and **DemandApp** registers. Start a new demand interval.
- **3** - Zero **DemandMin**, **DemandMax**, **Demand**, **DemandA**, **DemandB**, **DemandC** and **DemandApp** registers. Start a new demand interval.

I/O Pin Options Configuration

IoPinMode (1623)

For details about the I/O pin options registers and configuration, see the Continental Control Systems website: http://www.ccontrols.com/w/WattNode_Modbus_-_Option_IO.

Communication Registers

Most customers will never need these registers, but they can be useful for special situations. If you are using these registers to configure multiple WattNode meters, you may want to use the broadcast address (0) so that all meters will update together. This isn't permitted for setting the address, because then multiple devices would share the same address.

The communication configuration can be restored to factory defaults by switching all the DIP switches to the OFF position and leaving them OFF for 10 seconds, then setting them to the desired address and baud rate.

ApplyComConfig (1651)

If any of the following communication configuration registers are changed, the new values will not take effect until "1234" (decimal) is written to this register. This makes it easier to configure multiple changes and have them all take effect together.

Reads of **ApplyComConfig** will return "1" if there are any pending changes, otherwise "0".

Address (1652)

This register can override the DIP switch address setting and also allows addresses to be assigned up to 247 (the DIP switches can only set addresses up to 127). Set this register back to zero to use the DIP switch setting.

The meter can be ordered with **Option AD**, which factory assigns the address. See **Option AD (p. 20)** in the section **Setting the Modbus Address** for details.

BaudRate (1653)

This register overrides the DIP switch baud rate setting for speeds up to 38,400 baud.

- **0** - Use DIP switch assigned baud rate (9,600 or 19,200 baud)
- **1** - 1,200 baud
- **2** - 2,400 baud
- **3** - 4,800 baud
- **4** - 9,600 baud
- **5** - 19,200 baud
- **6** - 38,400 baud

The meter can be ordered with **Option 19K** or **Option 38K** to preconfigure the baud rate to 19,200 or 38,400 baud. See **Baud Rate (p. 20)** for details.

ParityMode (1654)

The WattNode Modbus meter defaults to no parity, eight data bits, and one stop bit, but even parity is supported using this register, or by ordering **Option EP** to preconfigure even parity

- **0** - N81 (no parity, one stop bit)
- **1** - E81 (even parity, one stop bit)

ModbusMode (1655)

- **0** - RTU - This is the default Modbus RTU binary protocol
- **1** - TCP-RTU - Emulates the Modbus TCP/IP binary protocol over RS-485

For some applications, it is desirable to convert the RS-485 to TCP/IP over Ethernet. The most common approaches are the following:

- 1) Use a Modbus RTU RS-485 to Modbus TCP/IP Ethernet gateway. These devices can translate the RTU packets into Modbus TCP/IP packets and retransmit them over Ethernet. These work well, but are specialized devices and somewhat expensive.
- 2) Use an RS-485 to Ethernet serial device adapter. These are less expensive than the Modbus gateways, but they do not convert protocols from Modbus RTU to Modbus TCP/IP. Most software designed to receive Modbus over an Ethernet connection will expect the Modbus TCP/IP protocol. In order to make this work, the meter can switch to the Modbus TCP/IP protocol (still using RS-485), which is nearly identical to Modbus RTU, but with a different header and no CRC bytes (TCP/IP has a built-in CRC).

For more information on Modbus over TCP/IP, see “Modbus Messaging on TCP/IP Implementation Guide - V1.0b”. Implementing a system using Modbus TCP/IP may be complex, so see http://www.ccontrols.com/w/WattNode_Modbus_-_Option_TCP-RTU and contact Continental Control Systems for assistance.

The meter can be ordered with **Option TCP-RTU** to preconfigure the TCP-RTU mode.

ReplyDelay (1656)

ReplyDelay configures a user-defined minimum Modbus reply delay between 5 and 180 milliseconds (the default is 5 milliseconds). This is useful with some Modbus master devices or software that can miss response data if the meter responds to a request too quickly.

Diagnostic Registers

SerialNumber (1701, 1702)

This is a 32 bit long integer register containing the meter’s serial number, as printed on the label.

UptimeSecs (1703, 1704)

This 32 bit long integer counts the number of seconds the meter has been running since the last power failure or reset. Resets can be caused by power brownouts or severe errors.

TotalSecs (1705, 1706)

This 32 bit long integer counts the total seconds of meter operation since factory calibration.

Model (1707)

This register can be used to determine the WattNode model.

- **201** - WNC-3Y-208-MB
- **202** - WNC-3Y-400-MB
- **203** - WNC-3Y-480-MB
- **204** - WNC-3Y-600-MB
- **205** - WNC-3D-240-MB
- **206** - WNC-3D-400-MB
- **207** - WNC-3D-480-MB

Version (1708)

This reports the WattNode Modbus meter firmware version. The firmware is not field upgradable.

Options (1709)

This register indicates factory configured options. For details, see http://www.ccontrols.com/w/WattNode_Modbus_Option_Identification.

PowerFailCount (1711)

This counts (up to 32767) the number of times power has been cycled on this meter.

Communication Error Counts

The following registers report communication error counts. Each register counts up to 32767 and stops. All four of these registers are reset to zero whenever power is cycled or by writing zero to any of them.

CrcErrorCount (1712)

This is the number (up to 32767) of packets with an invalid CRC (cyclic redundancy check).

FrameErrorCount (1713)

This is the number (up to 32767) of Modbus packets with framing errors. A framing error can indicate bad baud rate, bad parity setting, RS-485 noise or interference, or an RS-485 bus collision.

PacketErrorCount (1714)

This counts (up to 32767) the number of Modbus packets that could not be parsed.

OverrunCount (1715)

This counts (up to 32767) the number of times the Modbus input buffer has been overrun. The buffer is 256 bytes and normal requests are less than 80 bytes, so an overrun normally indicates non-Modbus traffic on the RS-485 bus or severe noise on the bus.

Error Codes

ErrorStatus (1710)

ErrorStatus1 - ErrorStatus8 (1716 - 1723)

The ErrorStatus registers hold queues of the most recent eight errors or status notifications.

ErrorStatus allows access to the eight most recent errors from a single Modbus register. Each time you read it, you'll get another value (starting with the oldest). When there are no more errors, **ErrorStatus** will report 0. The **ErrorStatus** values are preserved across power failures.

ErrorStatus is generally best used with unattended data logging, since each error will only be reported once.

ErrorStatus1 through **ErrorStatus8** also list the eight most recent errors, but with a few differences. **ErrorStatus1** lists the most recent error or status, while **ErrorStatus8** lists the oldest. Reading these registers won't change the reported values for **ErrorStatus1** through **ErrorStatus8**, so they can be read repeatedly without clearing the values. **ErrorStatus1** through **ErrorStatus8** can all be cleared by writing 0 to any of them. They are **not** preserved across power failures. **ErrorStatus1** through **ErrorStatus8** are generally best used when a person will be looking at the values in real time, because they provide a visual history of recent errors and events and will not be cleared when they are read.

The following lists many of the error and status code values. For any not listed or those marked "ERROR" contact technical support.

- **0**: No error or status messages.
- **1-49, 50-58, 60-61, 71-73**: ERROR: Internal firmware error. Contact technical support.
- **59**: ERROR: Non-volatile data lost: energy, peak demand, etc.
- **62-66**: WARNING: Internal energy measurement overflow
- **67**: ERROR: Calibration data lost. Meter will not function until it is recalibrated.
- **68**: ERROR: Configuration data lost (CtAmps, etc.)
- **69**: WARNING: Could not measure AC line frequency, may indicate high noise condition.
- **70, 74**: ERROR: Non-volatile memory failure: energy, demand, etc. will be lost when power fails.
- **75-77**: ERROR: Internal measurement error.
- **78-83**: WARNING: Measured high AC line voltage. Sustained high voltage may damage the WattNode.
- **84, 85, 86**: INFO: **EnergyA, B, C** registers overflowed 100 gigawatt-hours, reset to 0.
- **87**: INFO: **EnergySum** register overflowed 100 gigawatt-hours, reset to 0.
- **88**: INFO: **EnergySumNR** register overflowed 100 gigawatt-hours, reset to 0.
- **89, 90, 91**: INFO: **EnergyReacA, B, C** registers overflowed 100 gigawatt-hours, reset to 0.
- **92**: INFO: **EnergyReacSum** register overflowed 100 gigawatt-hours, reset to 0.
- **93, 94, 95**: INFO: **EnergyPosA, B, C** registers overflowed 100 gigawatt-hours, reset to 0.
- **96**: INFO: **EnergyPosSum** register overflowed 100 gigawatt-hours, reset to 0.
- **97**: INFO: **EnergyPosSumNR** register overflowed 100 gigawatt-hours, reset to 0.
- **98, 99, 100**: INFO: **EnergyNegA, B, C** registers overflowed 100 gigawatt-hours, reset to 0.
- **101**: INFO: **EnergyNegSum** register overflowed 100 gigawatt-hours, reset to 0.
- **102**: INFO: **EnergyNegSumNR** register overflowed 100 gigawatt-hours, reset to 0.
- **103, 104, 105**: INFO: **EnergyAppA, B, C** registers overflowed 100 gigawatt-hours, reset to 0.
- **106**: INFO: **EnergyAppSum** register overflowed 100 gigawatt-hours, reset to 0.
- **107**: INFO: **PulseCount** register overflowed from 4,294,967,295 to zero.
- **197**: WARNING: Tried to write to read-only register.
- **198**: WARNING: **IoPinMode** write not allowed because required option not installed.
- **199**: WARNING: **IoPinState** write command rejected because **IoPinMode** is an input.
- **200**: WARNING: Configuration register cannot be changed without entering **ConfigPasscode** first.
- **202**: WARNING: **ConfigPasscode** update failed because second write (verify) did not match the first write.
- **203**: WARNING: A write to a dual register (typically **ConfigPasscode**) was aborted.
- **205**: WARNING: Invalid **ConfigPasscode** entered.
- **206**: WARNING: Invalid Modbus register address specified.

- **207:** WARNING: Invalid Modbus register data value specified.
- **208:** WARNING: Invalid configuration register value specified.
- **209:** INFO: **ConfigPasscode** unlock attempt rejected because it was within five seconds of a previous failed attempt.
- **211:** WARNING: Invalid Modbus write length specified.
- **212:** WARNING: Invalid Modbus single-register write length specified
- **213:** WARNING: Invalid Modbus function code specified.
- **215:** WARNING: Slave device failure exception occurred: **ConfigPasscode** required, etc.
- **216:** ERROR: Custom register map error. Custom map disabled.
- **220:** INFO: Factory reset of energies completed.
- **241:** WARNING: Invalid Modbus TCP/IP header.
- **242, 246:** WARNING: Modbus collision. The meter received extra data after receiving a command. This may indicate an address conflict or electrical interference.
- **243:** WARNING: Invalid Modbus message length.
- **244:** WARNING: Timeout receiving the Modbus TCP header (only applies in TCP-RTU mode).
- **245:** WARNING: Invalid length in the Modbus TCP header (only applies in TCP-RTU mode).
- **247:** WARNING: RS-485 parity error. Generally caused by baud rate mismatch, parity mode mismatch, or electrical interference.
- **248:** WARNING: RS-485 bus contention during transmit. Generally caused by two or more WattNode meters with duplicate Modbus addresses.
- **249:** WARNING: Duplicate Modbus address detected.
- **250:** WARNING: Modbus receiver overrun. This is generally caused by non-Modbus data on the bus or packets longer than 256 bytes.
- **251:** WARNING: RS-485 receiver error. Generally caused by baud rate mismatch, parity mode mismatch, or electrical interference.
- **252-253:** WARNING: Short Modbus packet detected (less than four bytes). Modbus RTU uses a brief pause (3.5 byte periods) to indicate the end of a packet, so any break in the stream of bytes can cause this, such as hot-connecting the RS-485 lines.
- **254:** WARNING: False Modbus start bit. This generally indicates electrical noise, or inadequate termination or biasing. See **Termination** and **Biasing** sections under **Connecting Modbus Outputs (p. 20)** for more information.
- **255:** WARNING: Invalid Modbus packet cyclic redundancy check (CRC). This generally indicates electrical noise on the RS-485 bus.

Maintenance and Repair

The WattNode Modbus meter requires no maintenance. There are no user serviceable or replaceable parts except the pluggable screw terminals.

The WattNode meter should not normally need to be cleaned, but if cleaning is desired, power must be disconnected first and a dry or damp cloth or brush should be used.

The WattNode meter is not user serviceable. In the event of any failure, the meter must be returned for service (contact CCS for an RMA). In the case of a new installation, follow the diagnostic and troubleshooting instructions before returning the meter for service, to ensure that the problem is not connection related.

Specifications

Models

Model	Nominal Vac Line-to-Neutral	Nominal Vac Line-to-Line	Phases	Wires
WNC-3Y-208-MB RWNC-3Y-208-MB	120	208–240	3	4
WNC-3Y-400-MB RWNC-3Y-400-MB	230	400	3	4
WNC-3Y-480-MB RWNC-3Y-480-MB	277	480	3	4
WNC-3Y-600-MB RWNC-3Y-600-MB	347	600	3	4
WNC-3D-240-MB RWNC-3D-240-MB	120*	208–240	3	3–4
WNC-3D-400-MB RWNC-3D-400-MB	230*	400	3	3–4
WNC-3D-480-MB RWNC-3D-480-MB	277*	480	3	3–4

*Note: the delta models have an optional neutral connection that may be used for measuring wye circuits. In the absence of neutral, voltages are measured with respect to ground. Delta WattNode models use the phase A and phase B connections for power.

Table 12: WattNode Models

Model Options

Any of these models are available with the following options. See the CCS website [WattNode Modbus - Options](#) page for details.

General Options

Option CT=xxx: Pre-assign xxx as the global **CtAmps** value of the attached current transformers.

Option CT=xxx/yyy/zzz: Pre-assign xxx to **CtAmpsA**, yyy to **CtAmpsB**, and zzz to **CtAmpsC**. This is used if non-matching CTs are connected to different phases.

Communication Options

Option EP: Factory configure the Modbus RS-485 communications to even parity (E81).

Parity: even

Data bits: 8

Stop bits: 1

Option 19K: Factory configure the RS-485 communications 19,200 baud. Position 8 of the DIP switch will be ignored.

Option 38K: Factory configure the RS-485 communications to 38,400 baud. Position 8 of the DIP switch will be ignored.

Option TCP-RTU: Configure the communications to the Modbus TCP-RTU protocol option for use with RS-485 to Ethernet gateways (serial device adapters).

Option AD: Factory configure the Modbus address. The DIP switch address will be ignored.

X Terminal Options

These options all utilize the **X** (auxiliary) terminal on the **MODBUS** connector:

Option X5: Provides 5 Vdc at up to 60 milliamps between the **C** (common) and **X** (5 V) terminals.

Output Voltage: 5 Vdc \pm 5%

Minimum Output Current: 0 mA

Maximum Output Current: 60 mA

Maximum Short-Circuit Output Current: 150 mA

Recommended Maximum 5 V Wire Length: 30 cm (1 foot)

Option IO: Provides a digital input (level sensing and pulse counting) or output (for load shedding and other applications) on the **X** terminal.

Option SSR: Provides a solid-state relay (contact closure) output between the **X** and **C** terminals for load shedding and other applications.

Special Options

Contact the factory about the following special options:

Option 232: Provide RS-232 I/O in place of RS-485.

Option TTL: Provide 5 V TTL UART I/O in place of RS-485.

Accuracy

The following accuracy specifications do not include errors caused by the current transformer accuracy or phase angle errors. "Rated current" is the current that generates a CT output voltage of 0.33333 Vac.

Condition 1 - Normal Operation

Line voltage: -20% to +15% of nominal

Power factor: 1.0

Frequency: 48 - 62 Hz

Ambient Temperature: 25°C

CT Current: 5% - 100% of rated current

Accuracy: \pm 0.5% of reading

Condition 2 - Low CT Current

All conditions the same as **Condition 1** except:

CT Current: 1% - 5% of rated current

Accuracy: \pm 1.0% of reading

Condition 3 - Very Low CT Current

All conditions the same as **Condition 1** except:

CT Current: 0.2% - 1% of rated current

Accuracy: \pm 3.0% of reading

Condition 4 - High CT Current

All conditions the same as **Condition 1** except:

CT Current: 100% - 120% of rated current

Accuracy: \pm 1.0% of reading

Condition 5 - Low Power Factor

All conditions the same as **Condition 1** except:

Power factor: 0.5 (\pm 60 degree phase shift between current and voltage)

Additional Error: $\pm 0.5\%$ of reading

Condition 6 - Temperature Variation

All conditions the same as Condition 1 except:

Ambient Temperature: -30°C to $+55^{\circ}\text{C}$

Additional Error: $\pm 0.75\%$ of reading

Measurement

Creep Limit: 0.10% (1/1000th) of full-scale. Whenever the power or reactive power for a phase drops below the creep limit, the power or reactive power for the phase will be forced to zero. Also, if the line voltage for a phase drops below 20% of nominal Vac, the output power for the phase will be set to zero. These limits prevent spurious readings due to measurement noise. To customize the creep limit, see **CreepLimit (1618)** in **Configuration Registers (p. 46)**.

Update Rate: 1.0 second. Internally, all measurements are performed at this rate.

Start-Up Time: Approximately 1.0 second. The meter starts measuring 50-100 milliseconds after AC power is applied, but requires a full 1.0 second measurement cycle before it starts reporting data. The WattNode meter does not respond to Modbus packets during this start-up time.

Current Transformer Phase Angle Correction: 1.0 degree leading. Current transformers (CTs) typically have a leading phase angle error ranging from 0.2 degrees to 2.5 degrees. The WattNode meter is normally programmed to correct for a 1.0 degree phase lead to provide good accuracy with typical CTs. The CT phase angle correction can be changed using the **PhaseAdjustA**, **PhaseAdjustB**, **PhaseAdjustC** registers.

Over-Voltage Limit: 125% of nominal Vac. If the line voltage for one or more phases exceeds this limit, the status LEDs for these phases will flash alternating red-green as a warning. Extended over-voltage operation can damage the meter and void the warranty. See **Line Voltage Too High (p. 24)**.

Over-Current Limit: 120% of rated current. Exceeding 120% of rated current will not harm the WattNode meter but the current and power will not be measured accurately.

Modbus Communication

Protocol: Modbus RTU (binary)

Baud Rates: 1200, 2400, 4800, 9600, 19200, and 38400

Duplex: Half (two-wire plus common)

Polarity Auto-detect: will automatically correct swapped A- and B+ terminals provided network has at least 200 millivolt bias between A- and B+.

Parity:

Standard: N81 (no parity, eight data bits, one stop bit)

Optional: E81 (even parity, eight data bits, one stop bit)

Modbus Buffer: 256 bytes

Communication Response Time: 5 - 25 milliseconds (may be longer immediately after a Modbus write command while values are saved to non-volatile memory).

EIA RS-485 Interface:

RS-485 Output Isolation: 4500 Vac RMS

Driver Output Voltage (Open Circuit): ± 6 Vdc maximum

Driver Output Voltage (54 Ω load): ± 1.5 Vdc minimum

Driver Output Current (54 Ω load): ± 60 mA typical

Driver Output Rise Time (54 Ω || 50 pF load): 900 nS typical

Receiver Common-Mode Voltage Range: -7 Vdc to +12 Vdc maximum

Receiver Sensitivity: ± 200 mV

Receiver Bus Load: 1/8 unit load (up to 256 WattNode meters per subnet)

Receiver Failsafe Modes: bus open, bus shorted, bus idle

Electrical

Power Consumption: The following table shows typical power consumption and power factor values with all three phases powered at nominal line voltages. The power supply draws most of the total power consumed, while the measurement circuitry draws 1-10% of the total (6-96 milliwatts per phase, depending on the model). Due to the design of the power supply, WattNode meters draw slightly more power at 50 Hz.

Model	Real Power (60 Hz)	Real Power (50 Hz)	Power Factor	Rated VA ⁽¹⁾	Power Supply Range (Vac)	Power Supply Terminals
WNC-3Y-208-MB	1.5 W	1.8 W	0.79	4 VA	96 – 138	N and ϕA
WNC-3Y-400-MB	1.6 W	1.8 W	0.73	4 VA	184 – 264	N and ϕA
WNC-3Y-480-MB	1.6 W	2.0 W	0.69	4 VA	222 – 318	N and ϕA
WNC-3Y-600-MB	1.0 W	1.3 W	0.76	4 VA	278 – 399	N and ϕA
WNC-3D-240-MB	1.2 W	1.5 W	0.70	4 VA	166 – 276	ϕA and ϕB
WNC-3D-400-MB	1.1 W	1.4 W	0.67	3 VA	320 – 460	ϕA and ϕB
WNC-3D-480-MB	1.2 W	1.6 W	0.70	3 VA	384 – 552	ϕA and ϕB

Table 13: Power Supply Characteristics

⁽¹⁾Note: This is the maximum at 115% of nominal Vac at 50 Hz. This is the same as the value that appears on the front label of the meter.

Maximum Power Supply Voltage Range: -20% to +15% of nominal (see table above). For the WNC-3D-240-MB, this is -20% of 208 Vac (166 Vac) to +15% of 240 Vac (276 Vac).

Operating Frequencies: 50/60 Hz

Measurement Category: CAT III

Measurement category III is for measurements performed in the building installation. Examples are measurements on distribution boards, circuit-breakers, wiring, including cables, bus-bars, junction boxes, switches, socket-outlets in the fixed installation, and equipment for industrial use and some other equipment, for example, stationary motors with permanent connection to the fixed installation.

The line voltage measurement terminals on the meter are rated for the following CAT III voltages (these ratings also appear on the front label):

Model	CAT III Voltage Rating
WNC-3Y-208-MB WNC-3D-240-MB	240 Vac
WNC-3Y-400-MB WNC-3D-400-MB	400 Vac
WNC-3Y-480-MB WNC-3D-480-MB	480 Vac
WNC-3Y-600-MB	600 Vac

Table 14: WattNode CAT III Ratings

Current Transformer Inputs:

Nominal Input Voltage (At CT Rated Current): 0.33333 Vac RMS

Absolute Maximum Input Voltage: 5.0 Vac RMS

Input Impedance at 50/60 Hz: 23 k Ω

Certifications

Safety: UL 61010-1; CAN/CSA-C22.2 No. 61010-1-04; IEC 61010-1

Immunity: EN 61326: 2002 (Industrial Locations)

Electrostatic Discharge: EN 61000-4-2: 4 kV contact, 8 kV air: (B) Self-Recovering

Radiated RF Immunity: EN 61000-4-3: 10 V/m: (A) No Degradation

Electrical Fast Transient / Burst: EN 61000-4-4: 2 kV: (B) Self-Recovering

Surge Immunity: EN 61000-4-5: 1 kV I/O, 4 kV AC: (B) Self-Recovering

Conducted RF Immunity: EN 61000-4-6: 3 V: (A) No Degradation

Voltage Dips, Interrupts: EN 61000-4-11: (B) Self-Recovering

Emissions: FCC Part 15, Class B; EN 55022: 1994, Class B

Environmental

Operating Temperature: -30°C to +55°C (-22°F to 131°F)

Altitude: Up to 2000 m (6560 ft)

Operating Humidity: non-condensing, 5 to 90% relative humidity (RH) up to 40°C, decreasing linearly to 50% RH at 55°C.

Pollution: POLLUTION DEGREE 2 - Normally only non-conductive pollution; occasionally, a temporary conductivity caused by condensation must be expected.

Indoor Use: Suitable for indoor use.

Outdoor Use: Suitable for outdoor use when mounted inside an electrical enclosure (Hammond Mfg., Type EJ Series) that is rated NEMA 3R or 4 (IP 66).

Mechanical

Enclosure: High impact, ABS and/or ABS/PC plastic

Flame Resistance Rating: UL 94V-0, IEC FV-0

Size: 153 mm × 85 mm × 38 mm (6.02 in × 3.35 in × 1.50 in)

Weight: 307 gm (10.8 oz)

Connectors: Euroblock style pluggable terminal blocks

Green: up to 12 AWG (2.5 mm²), 600 V

Black: up to 12 AWG (2.5 mm²), 300 V

Current Transformers

WattNode meters use CTs with built-in burden resistors generating 0.33333 Vac at rated AC current. The maximum input current rating is dependent on the CT model. Exceeding the maximum input current rating may damage the CT, but should not harm the meter.

None of these CTs measure DC current and the accuracy can be degraded in the presence of DC currents, as from half-wave rectified loads. The solid-core CTs are most susceptible to saturation due to DC currents. Rogowski coil CTs do not measure DC, but their accuracy is not degraded by DC.

To meet the UL listing requirements, the WattNode meter may only be used with these UL listed or recognized current transformer models. These all generate 333.33 millivolts AC at rated current. See the current transformer datasheets for CT ratings.

ACT-0750-xxx

CTL-1250-xxx

CTM-0360-xxx

CTS-0750-xxx

CTS-1250-xxx

CTS-2000-xxxx

CTB-WxL-xxxx

CTBL-WxL-xxxx

CTT-0300-xxx

CTT-0500-xxx

CTT-0750-xxx

CTT-1000-xxx

CTT-1250-xxx

CTRC-yyyyy-xxxx

- “xxx” indicates the full scale current rating.
- “WxL” indicates the opening width (W) and leg length (L) in inches.
- “dddd” indicates the opening diameter of the loop for flexible Rogowski CTs.
- “yyyyy” indicates the opening size in mils (thousandths of inches).

Common CT Specifications

Type: voltage output, integral burden resistor

Output Voltage at Rated Current: 0.33333 Vac (one-third volt)

Standard CT Wire Length: 2.4 m (8 feet)

Warranty

All products sold by Continental Control Systems, LLC (CCS) are guaranteed against defects in material and workmanship for a period of five years from the original date of shipment. CCS's responsibility is limited to repair, replacement, or refund, any of which may be selected by CCS at its sole discretion. CCS reserves the right to substitute functionally equivalent new or serviceable used parts.

This warranty covers only defects arising under normal use and does not include malfunctions or failures resulting from: misuse, neglect, improper application, improper installation, water damage, acts of nature, lightning, product modifications, alterations or repairs by anyone other than CCS.

Except as set forth herein, CCS makes no warranties, expressed or implied, and CCS disclaims and negates all other warranties, including without limitation, implied warranties of merchantability and fitness for a particular purpose.

Limitation of Liability

In no event shall CCS be liable for any indirect, special, incidental, punitive or consequential damages of any kind or nature arising out of the sale or use of its products whether such liability is asserted on the basis of contract, tort or otherwise, including without limitation, lost profits, even if CCS has been advised of the possibility of such damages.

Customer acknowledges that CCS's aggregate liability to Customer relating to or arising out of the sale or use of CCS's products, whether such liability is asserted on the basis of contract, tort or otherwise, shall not exceed the purchase price paid by Customer for the products in respect of which damages are claimed. Customer specifically acknowledges that CCS's price for the products is based upon the limitations of CCS's liability set forth herein.