

Description



Tstat7 keypad open



Tstat7 keypad close



Tstat7

Excellent thermostat with high accuracy temperature sensor and PI algorithm provide a comfortable indoor environment with its built in sensor, which is located in the controller and it will not be affected by the temperature off the wall on which it is mounted on. It is possible to connect an external sensor for monitoring the temperature of different locations.

This full-featured CPU based thermostat is designed for small cooling and heating air handling systems in residential and commercial facilities. The unit provides features which eclipse standard mechanical thermostats at a price that fits conventional HVAC projects. BACnet MS/TP and Modbus RTU protocols over RS485.

Specifications

Relays x 1amps @24V	8 analog inputs
2 analog outputs	(10V @100ma)
Temperature range	40~100°C (-40~212°F)
Supply voltage	24VAC ±20%, 50-60Hz
Power consumption	100mA at 12VDC
Relay contacts rating	Max 6A
Operation	0~70°C (32~158°F)
Controlling	40~100°C (-40~212°F)
Storage	2~50°C (35~120°F)
Ambient humidity	10-90 % Rh
Operating Environment	0 ~ 99% humidity (non condensing)
Material enclosure	Flame proof plastic
Enclosure rating	IP31
Temperature sensor	10K thermistor ±0.5°C
Weight	200 grams
Color	White and off-white

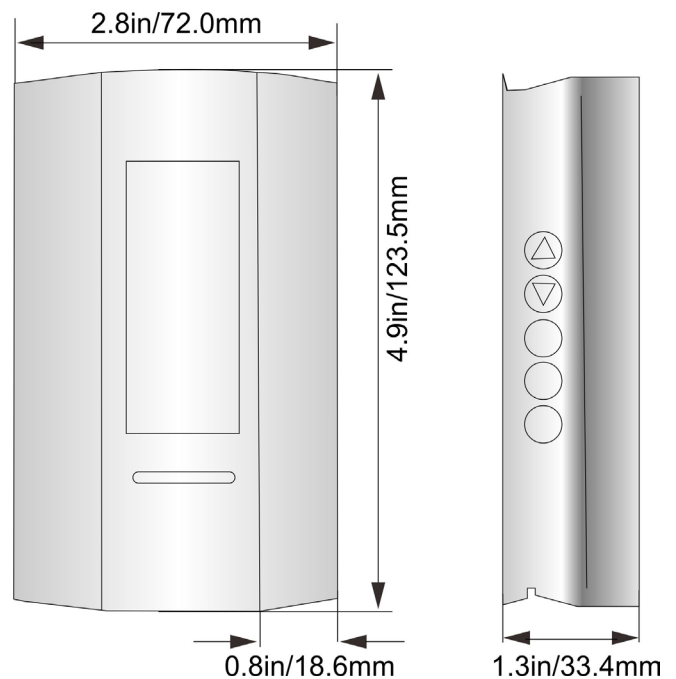

Part Number Scheme

TSTAT7-H

Code	Description
TSTAT7	Thermostat

Code	Option
	Temperature&Clock
Occ	Clock&Temperature&Occupancy sensor
H	Clock&Temperature&humidity

Typical Wire Routing

For proper safety all wiring and controllers should be installed separately to avoid accidentally contact with one another. Make sure to keep wiring and equipment/controllers six feet from power distribution, motors, etc. If these conditions are not satisfied; irregularities can occur with the system.

With this easy to install and manage product, building developers/managers can deliver a system that exceeds expectations. Comfort control is made possible at a cost savings like no other.



Wiring Diagram

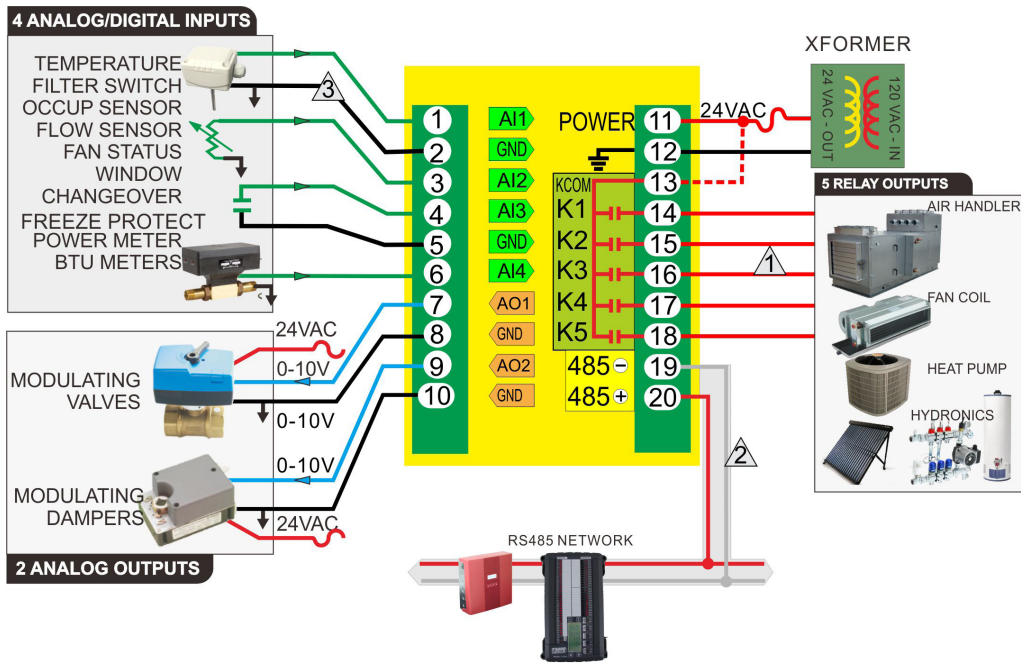

- ⚠️ Relay outputs: 24VAC@1amp max, 3 amp combined max for all 5 outputs
- ⚠️ RS485 network, 2 conductor with optional shield, 1200 meters and 64 devices max
- ⚠️ Sensors, valves, dampers and equipment all share one common ground

The wiring diagram above outlines the basic functions the TSTAT7 thermostat can do for you. With four analog/digital inputs you can plug in occupancy sensors, flow sensors, fan status, freeze protection, power meters and BTU meters just to name a few. There are 2 analog outputs that can be used for modulating valves and modulating dampers. It comes equipped with a RS485 network that can be connected to a controller like a boiler as illustrated above.

On the other side we have five relay output capabilities which can be used for air handler units, fan coil units, heat pumps and many other different types of hydronic applications.

The TSTAT7 thermostat is compatible with any desire you need and the perfect fit for your next installation.





Operational Functions

1) Adjustable set-points

The buttons both the up arrow and down arrow allow the consumer to increase or decrease the desired set-point they wish to have. To adjust the set-point on the room sensor can only be done when the occupied symbol is being displayed on the LCD display. To increase the set-point temperature by a degree simply hit the up arrow button. To decrease the set-point temperature by a degree simply hit the down arrow button and continue either step until desired set-point is achieved. After the set-point is increased or decreased the LCD screen will display the current set-point, until the temperature in the room reaches the desired set-point (warmer/cooler) of the occupant.

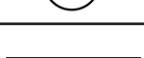

2) There are six buttons that operate the Tstat7:

Buttons		Functions
	Top button (right side)	Increases setpoint
	Second button from top (right side)	Decreases setpoint
	FAN Mode: Middle button (right side)	Adjusts manually/automatically the fan speed to satisfy cool air temperature
	Main MENU: Second button from bottom (right side)	Optimizes the settings of heating/cooling, clock, schedule, etc
	Ok: First button from bottom (right side)	To save or enter a setting in the main menu
	Override switch unmarked (center of front cover)	For new occupancy adjustments

a. Normal state

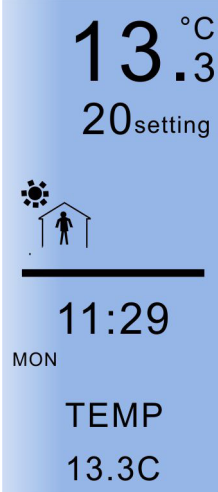

b. When press mode key, it will be switched between fan mode and heat\cool. When press up and down keys, it will go into the fan mode list or heat cool list.

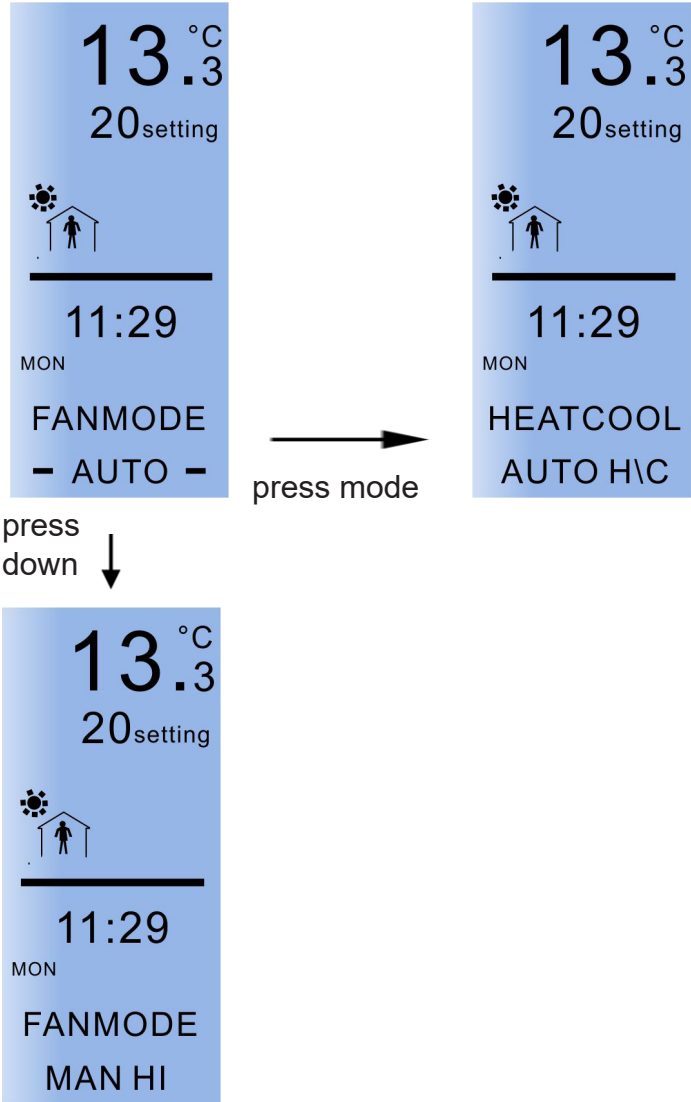

c. Now you are in the normal state, when press menu key, it will be switched between schedule, clock, advanced.

When it comes to schedule, press OK, go into the day set list.

Press menu key go into the occupied/unoccupied time set and press up/down arrow key, will increase or decrease the hour. Press menu key, it will switch to the minute list.

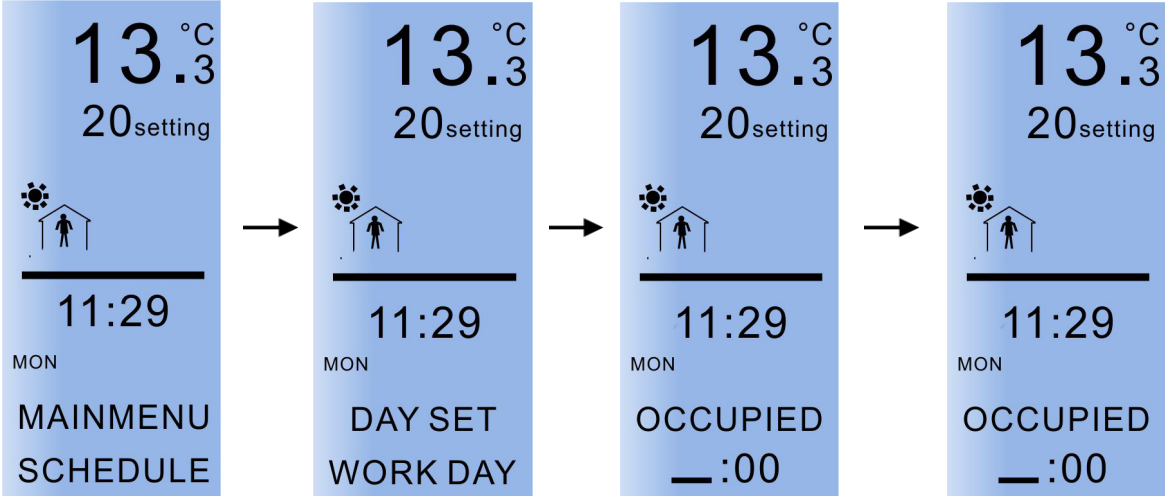

b. Now you are in the normal state, when the menu key is pressed, the unit will switch between schedule, clock and advanced screens. To change the unit's ID press menu and keep pressing menu until 'advanced' is displayed on the screen. Press 'ok' and it will display 'sensor internal'. Repeatedly press menu until you reach 'net ID'. To change the net ID press the up and down arrows to increase or decrease the value from 1 to 254. Upon choosing a desired value, leave the unit for six seconds and the value will be stored.

3) LCD Display Features

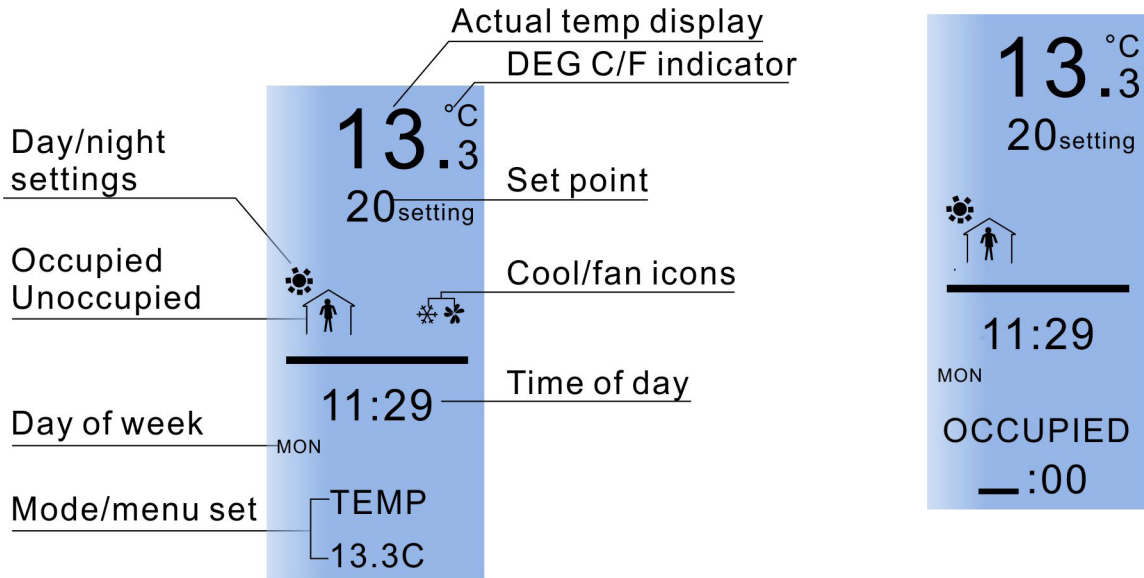

The LCD panel displays a wide variety of functions that Tstat7 thermostat can do to create a comfort level like no other. Be able to automatically adjust the heat, cool, and fan modes to which ever temperature you desire; day or night. You can also program the thermostat to operate at a lower level when the room or building is unoccupied, saving energy and costs on your electric bill, what's more, the earth will become more and more beautiful and ecological.

Set net ID, Baudrate and protocol through main menu button

1. Press the menu several times to display advanced and then press "OK"



2. Press menu again (Press multiple times until the net ID option is found, Change by up and down key)



3. Press menu again (Press multiple times until the baudrate option is found, Change by up and down key)



4. Press menu again (press multiple times until the protocol option is found, press up and down to select Bacnet or Modbus)



Installation Mounting

1) Unfasten the screw located at the base and lift off the front panel of the enclosure.

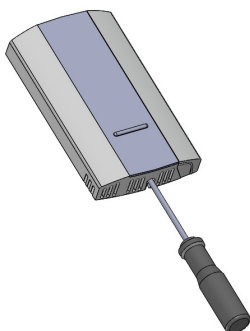

2) Wall mount: Fasten the screws on the back panel to the wall, and re-attach the front panel to the now mounted panel. Refasten the screw at the base connecting both panels. **OR**

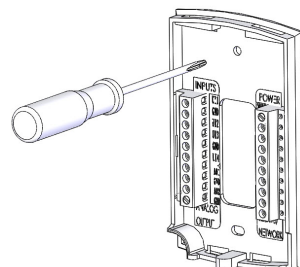

3) Standard '11-10' electrical box: Fasten the screws on the back panel to the electrical box, and re-attach the front panel to the now mounted panel. Refasten the screw at the base connecting both panels.

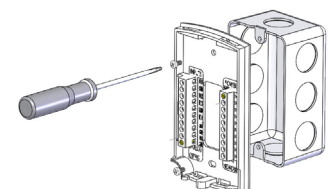

T3000 Software Instructions

1. Visit <https://tinyurl.com/y7uyu9n3>, download T3000 software and install it;
2. Connect Tstat7 to PC via RS485 at pin 19 and 20. Start the software T3000, it will open below the view.

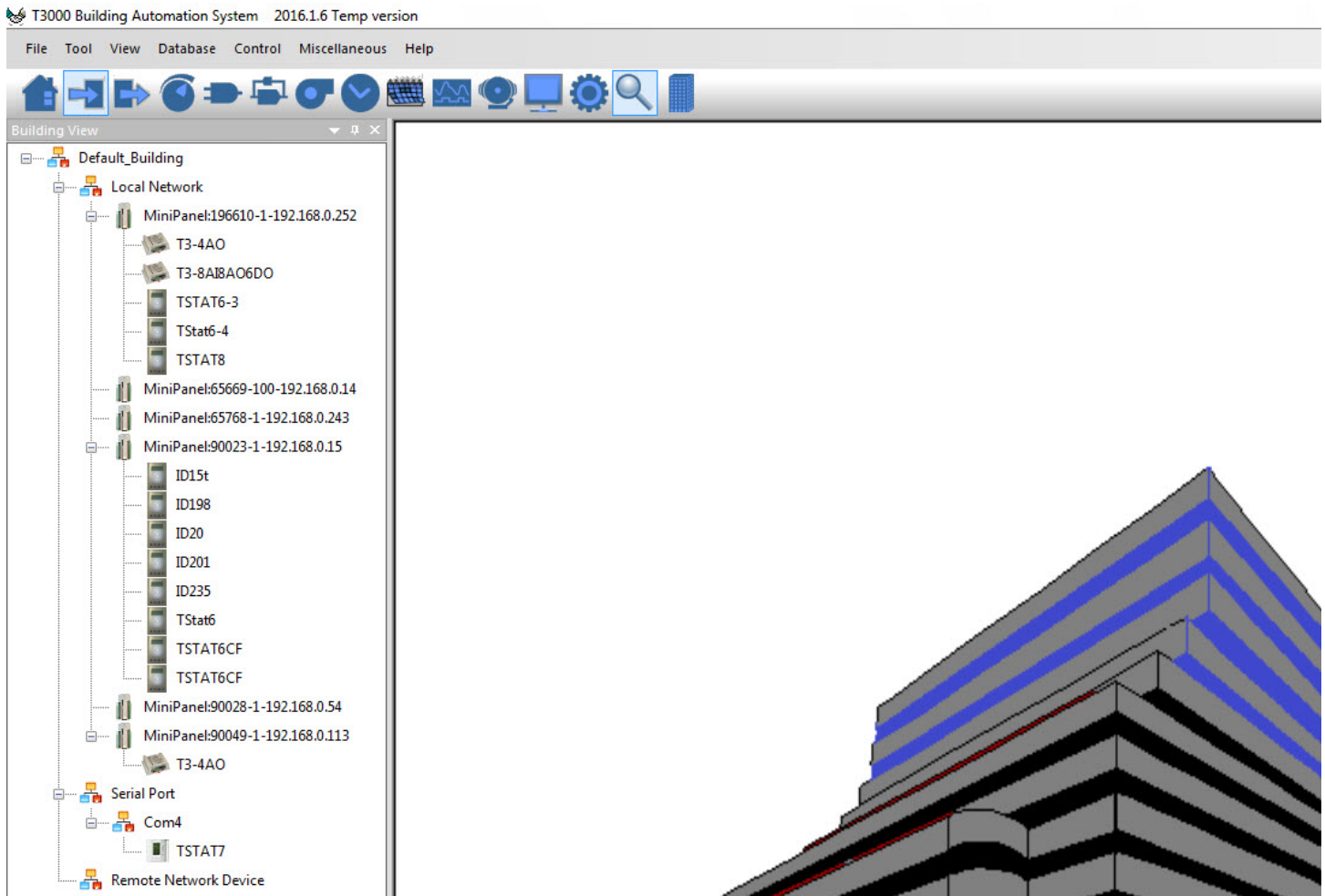

3. Click the button to scan, and the following view will appear then close the popup. It shows the tstat7 has been connected.

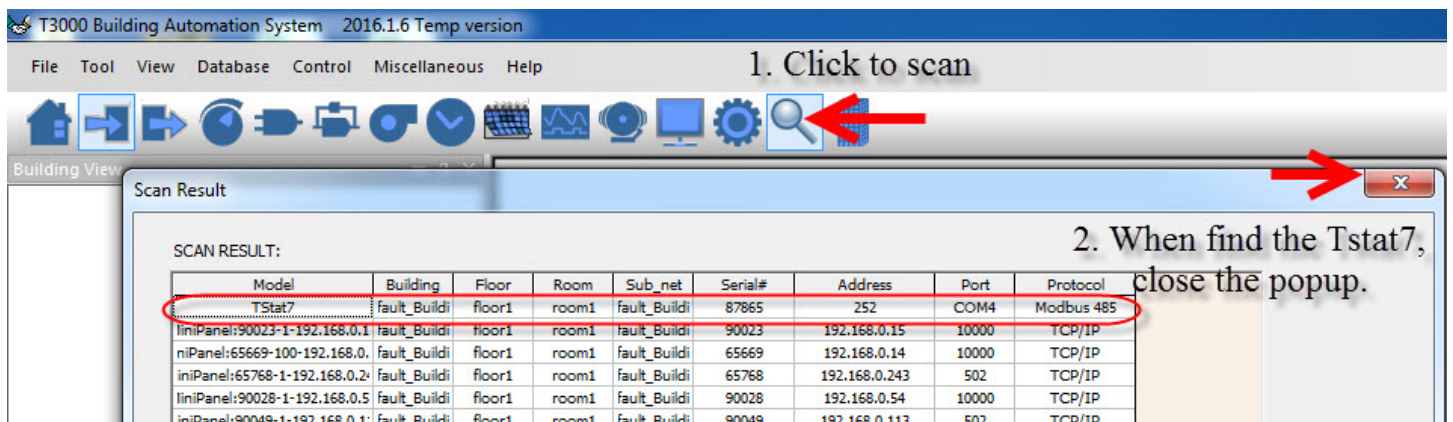

6. When press the setting button, it will show the parameter view. When click PIDs Table, it will open a PID popup.

T3000 Building Automation System 2016.1.6 Temp version

File Tool View Database Control Miscellaneous Help

Parameter

ID Address: 252 Enable Change Name: TSTAT7 Exit

General Setting

Baudrate: 19200 LCD Input Filter: 2 Occupied setpoint control Mode: Normal 1 Default: 20

Keypad Select: 4A Setpoint Increments: 1.0 Powerup Setpoint: 20 Short Cycle Delay: 0

Powerup Mode: Last Sequence: Fan Coil Rounding display: normal Keypad Lock: Lock Off

Temp Unit: °C heat/cool changeover: Auto (PID) Change over delay(min): 0 BackLight OFF Time: 1 min

Timer

General Setting Override Timer PIR Sensor Setting

Timer On: 0 Timer Off: 0 Units: Second Time Left: 0 min Override Period: 0 min Enable/Disable: Disable Setpoint Display: Temperat

Timer left: Timer Select: Period timer Tranducer Temperature Setting Sensitivity: 30

Day Setpoint

Loop	Day/Occ Setting	Max	Min	Cooling Dead Band	Heating Dead Band
Loop1	20.0	50	15	1.0°C	1.0°C
Loop2	200.0			0.1	0.1

Night Setpoint

Night/Unocc Mode: Office Cooling SetPoint: 22°C Heating SetPoint: 20°C

Setpoints

	DAY	NIGHT
1 SP/2 SP:	Dual	Dual
COOL DB:	1	1
SetPoint:	20	21
Heat DB:	1	1
Heat SP:	19	20
COOL SP:	21	22

PID

Loop	Input select	Input value	Setpt value	Output	Pterm	Item
Loop1	Internal Sensor	13.1°C	20	100%	6.0	5.0
Loop2	Avg Temperat	13.1	200.0	100%	100.0	1.0

PID2 off Setpoint: 300.0

Special Features

Free cooling Outdoor Reset

Valve Travel Time: 90

PIDs Table

PIDs Set Dialog

Fan Mode Name Configuration

Fan Off Model 1 Model 2 Model 3 Fan Aut

PID 1

Mode: Fan Off #Modes/Speeds: 5 Fan Auto Only: Heating Stages: 3 Cooling Stages: 3 Refresh Exit

	Description	Control	InterLock	Heat3	Heat2	Heat1	Coast	Cool1	Cool2	Cool3
1	Output1	PID1	-	Off	Off	Off	Off	Off	Off	Off
2	Output2	PID1	-	Off	Off	Off	Off	Off	Off	Off
3	Output3	PID1	-	Off	Off	Off	Off	Off	Off	Off
4	Output4	PID1	-	Off	Off	Off	Off	Off	Off	Off
5	Output5	PID1	-	Off	Off	Off	Off	Off	Off	Off
6	Output6	PID1	-	Closed	Closed	Closed	Closed	Closed	Closed	Closed
7	Output7	PID1	-	Closed	Closed	Closed	Closed	Closed	Closed	Closed

PID 2

Heating Stages: 3 Cooling Stages: 3

	Description	Control	Interlock	Heat3	Heat2	Heat1	Coast	Cool1	Cool2	Cool3
1	Output1	PID1	-							
2	Output2	PID1	-							
3	Output3	PID1	-							
4	Output4	PID1	-							
5	Output5	PID1	-							
6	Output6	PID1	-							
7	Output7	PID1	-							

Modbus Register List

The register list is very long ,it can be downloaded as an excel spreadsheet (03ModbusBacnetRegisterList.xls) at the following link:<http://tinyurl.com/ybaj9d3u>