

PM2.5 Particle Counter

Description

The PM2.5/10 Particle Counter is designed for environmental monitoring in industrial, commercial and institutional buildings. The unit provides accurate readings of particle counts in five important sizes, 0.5µm,1.0µm,2.5µm ,4µm and 10µm. The sensor uses the laser light scattering method which is not subject to drift or sensor contamination. A fixed volume of air is pumped through the sensor and suspended particulate matter in a given unit volume of air is totalized into two bins, one for particles of 2.5µm and another for larger 10 µm sizes. The results are reported in µg/m³ of air with all data available over the RS485 port for integration into large systems. It supports Modbus and Bacnet multiple protocols over both RS485 and Ethernet.



PM2.5/10-D



PM2.5/10-W

Highlights

- Accurate : Laser scatter method, particles are sized with a resolution of 0.3 µm.
- Fast response : Response time less than 8 seconds
- LCD display with backlight for keypad setup and troubleshooting
- Supports Modbus and Bacnet protocols
- With the jumper settings,PM2.5 and PM10 values can be converted to 4-20mA / 0-10V / 0-5V
- Warranty Period: The standard warranty is five years for electronics

Specifications

Measurement parameters	PM2.5,PM10
Mass concentration range	0.0-1000 µg / m ³
Mass concentration resolution	1 µg / m ³
Mass concentration accuracy	±10µg / m ³ @ 0 to100µg / m ³ , ±10%@100 to 1000µg / m ³
Minimum resolution of particle	0.3 µm
Start-up time	<8s
Sampling interval	1s
Response time	<1s

PM2.5 Particle Counter

Life Span	>8 years @24h/day operation
Acoustic emission level	25dB@0.2m
Air pressure	86KPa~110KPa
Display	130x80 dot matrix, backlit
Communications	Modbus TCP/IP and Bacnet IP over Ethernet Modbus RTU and Bacnet MSTP over RS485
Power supply voltage	15-24V +/- 10%, AC or DC, 2 watt typical
Operating Temp	-20~+60°C, 0-95% non condensing
Plastic Housing	Flammability rating UL 94V0 file, E194560, halogen free, IP65

Note: PM2.5 is particulate matter <2.5 µm in diameter; PM10 is particulate matter <10 µm in diameter.

AQI levels as defined by the China Ministry of Environmental Protection

Air Quality Index	Air Pollution Level	PM2.5 24hr avg (ug/m ³)	PM10 24hr avg (ug/m ³)
0-50	Good	0-35	0-50
50-100	Moderate	35-75	50-150
100-150	Unhealthy for Sensitive Groups	75-115	150-250
150-200	Unhealthy	115-150	250-350
200-300	Very Unhealthy	150-250	350-420
> 300	Hazardous	> 250	> 420

AQI levels as defined by the US Environmental Protection Agency

Air Quality Index	Air Pollution Level	PM2.5 24hr avg (ug/m ³)	PM10 24hr avg (ug/m ³)
0-50	Good	0-12	0-54
51-100	Moderate	12.1-35.4	55-154
101-150	Unhealthy for Sensitive Groups	35.5-55.4	155-254
151-200	Unhealthy	65.5-150.4	255-354
201-300	Very Unhealthy	150.5-250.4	355-424
301-500	Hazardous	250.5-500.4	425-604

PM2.5 Particle Counter

Part Number Scheme

PM2.5/10 - D - 150

Code	Description
PM2.5/10	PM2.5/10 Particle Counter

Code	Module
D	Duct Mount
W	Wall Mount

Code	Pitot Length
100	4"
150	6"
200	8"
250	10"
300	12"
*	Other custom lengths are available, no minimum order

Wiring Diagram

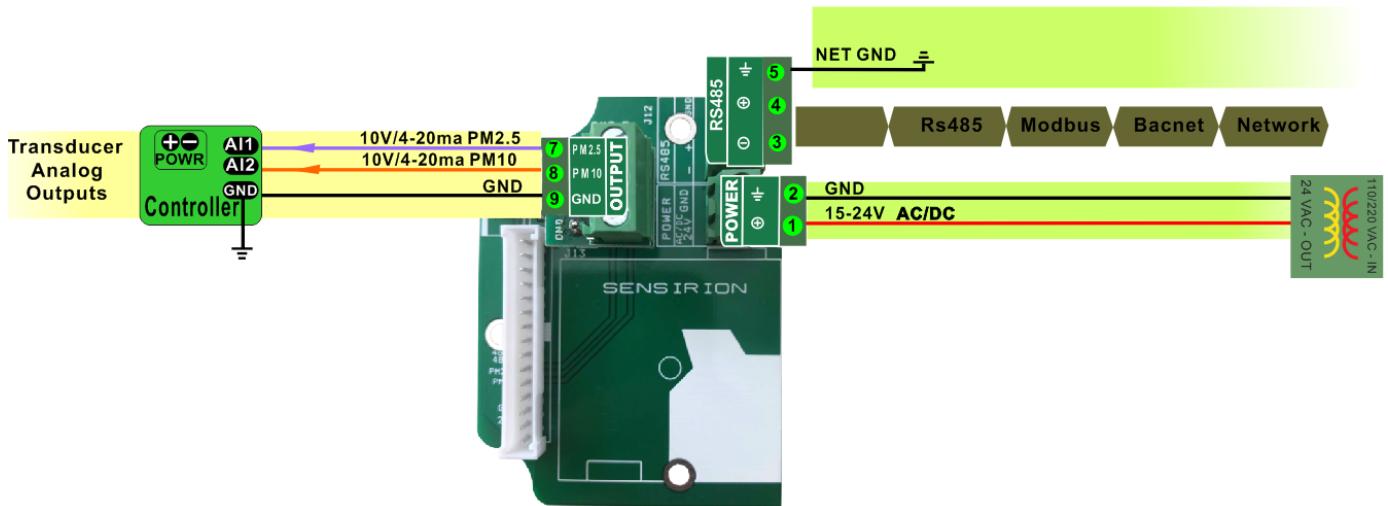

Output Jumper Settings

In this mode the device acts as a traditional transducer where it sends out two analog signals, all you need to do is to set this one single jumper to the appropriate signal type: 4-20mA, 0-10V, or 0-5V.

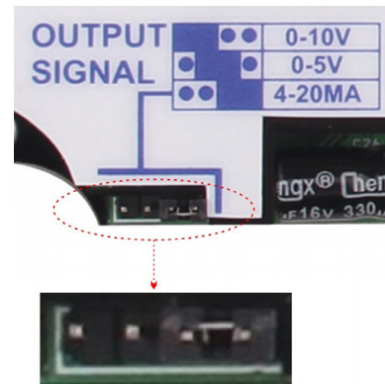

PM2.5 Particle Counter

Dimension

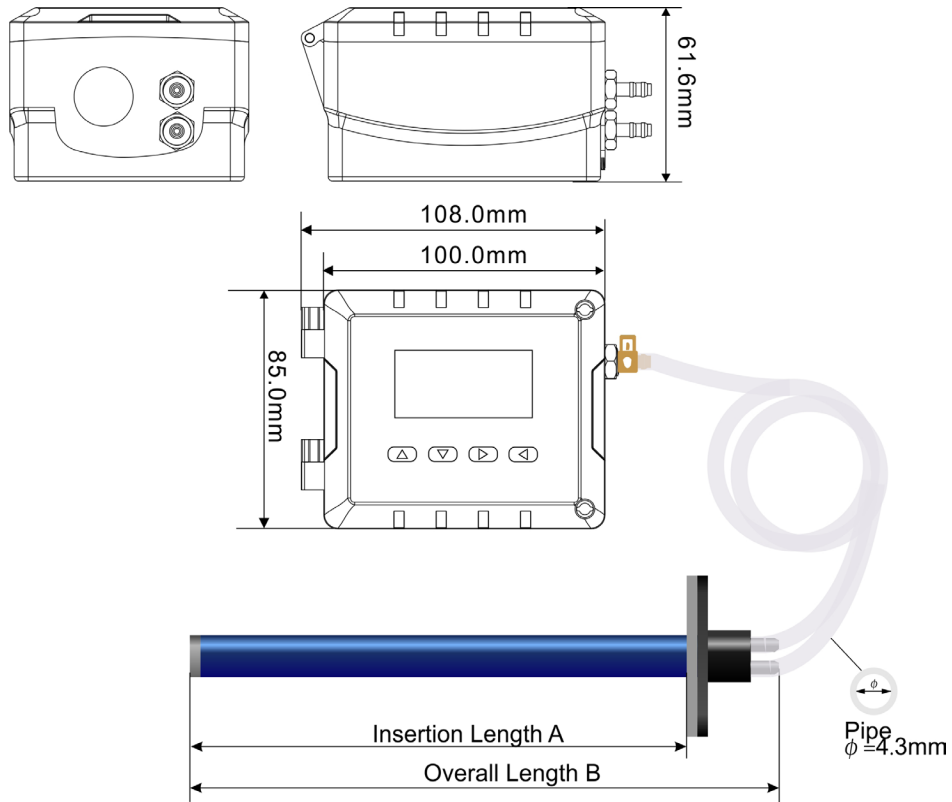

Insertion Length A (mm)	Overall Length B (mm)
150	193
200	243
250	293
300	343
1000	1043

Internal View

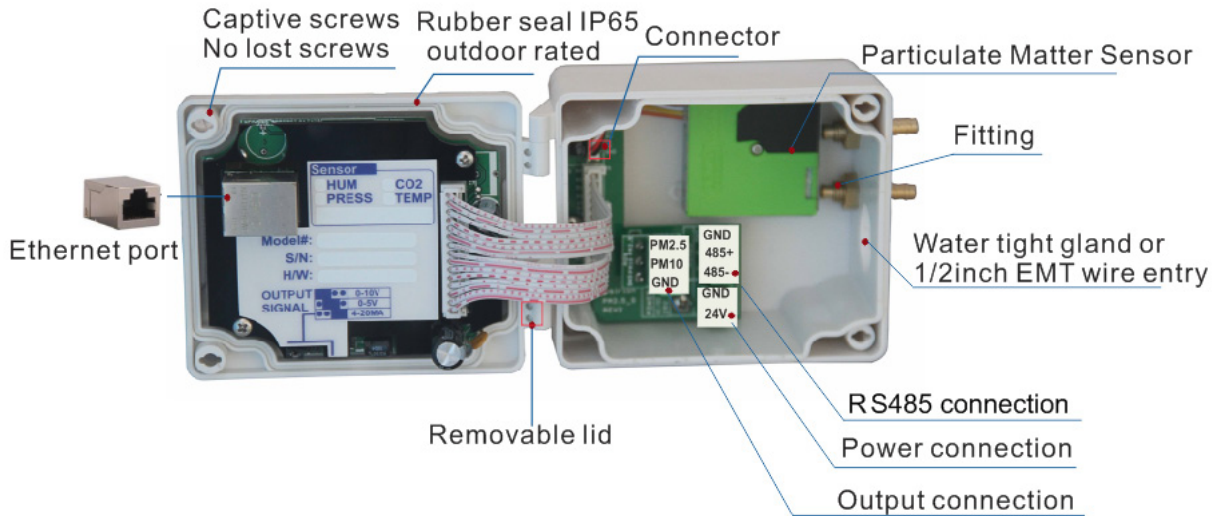

PM2.5 Particle Counter

Mounting Installation

1) Unfasten screw at cover, turn the captive screw 1/2 turn till it pops out.

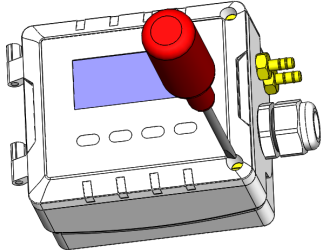

2) Rotate the captive screws with a flat screw driver. These screws are spring loaded and will pop out of their holding position when lined up with a slot in the cover.

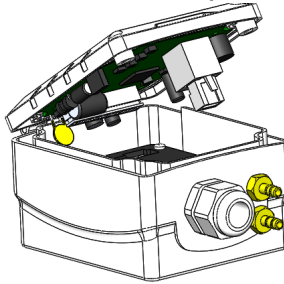

3) When the screws pop up you can raise the lid, you may need to pry the lid off a little with the screw driver if the captive screws are a tight fit.

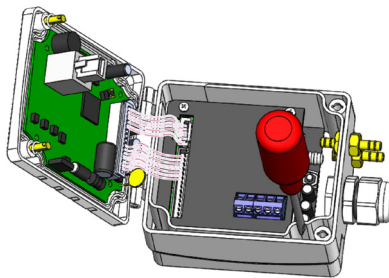
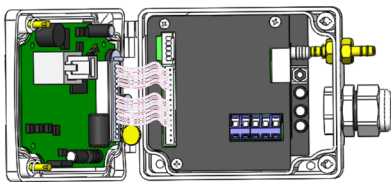

4) Re-fasten screw at cover.

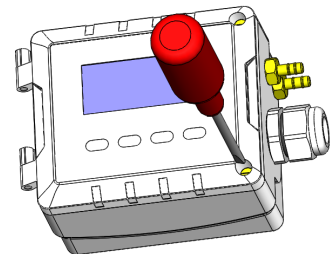

T3000 Operation

1. Visit <https://temcocontrols.com/ftp/software/09T3000Software.zip>, download T3000 software and install it;
2. Plug PM2.5 in power, connect it to PC via RS485;
3. Start T3000 software, click  to scan, then you can find PM2.5 as below

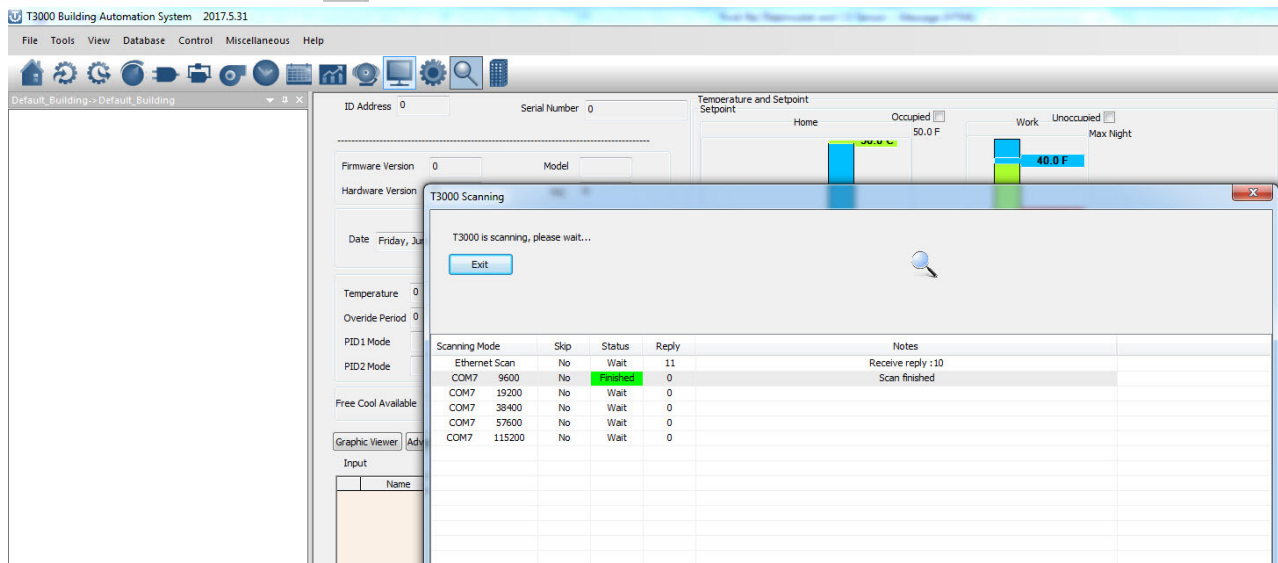

Scanning Mode	Skip	Status	Reply	Notes
Ethernet Scan	No	Wait	11	Receive reply : 10
COM7 9600	No	Finished	0	Scan finished
COM7 19200	No	Wait	0	
COM7 38400	No	Wait	0	
COM7 57600	No	Wait	0	
COM7 115200	No	Wait	0	

PM2.5 Particle Counter



4. Click to see the status of the PM2.5. This window will display setpoints, temperature, inputs and outputs.

The screenshot displays the T3000 Building Automation System interface. On the left, a tree view shows the device hierarchy under 'Default_Building->Default_Building'. The 'PM2.5' sensor is highlighted under the 'Virtual Device' section. The main panel shows the configuration for the selected device (ID Address 0, Serial Number 0). It includes fields for Firmware Version, Hardware Version, Model, and PIC. The current date is Friday, Jun 16, 2017, and the time is 05:29:08 PM. The temperature is set to 0.0 C. The fan mode is set to 'Cooling'. The override period is 0, and the time left is 0. The PID1 and PID2 modes are both set to 0%. The free cool feature is set to 'Normal'. The temperature and setpoint section shows a vertical bar chart with setpoints for Home (50.0 F), Occupied (40.0 F), and Work (15.0 F). The current temperature is 0.0 C. The status bar at the bottom shows 'Health: 100%' and 'Multi Read ID=252, start address=800, length=100, Status: Fail'.

PM2.5 Particle Counter

Modbus Register List

PM2.5 uses Modbus protocol to communicate with others. Below is modbus the register list .

Address	Register and Description
0 to 3	Serial Number -4 byte value. Read-only
4 to 5	Software Version –2 byte value. Read-only
6	ADDRESS. Modbus device address
7	Product Model. This is a read-only register that is used by the microcontroller to determine the product
8	Hardware Revision. This is a read-only register that is used by the microcontroller to determine the hardware Rev
9	PIC firmware version
10	'Plug n Play' address, used by the network master to resolve address conflicts. See VC code for algorithms
15	Bau - Baudrate, 0=9.6kbaud, 1=19.2kbaud 2=38.4kbaud 3=57.6kbaud 4=115.2kbaud
16	Firmware Update Register, used to show the status of firmware updates
21	Protocol switch. 3 = MODBUS,0=MSTP.
17-39	Blank, for future use
40 to 45	reg40, MAC address, read only normally
46	reg46, IP mode. 0=static IP; 1= DHCP
47 to 48	reg47, upper two bytes of IP address
49 to 50	reg49, lower two bytes of IP address
51 to 52	reg51, right two bytes of SUBNET MASK address
53 to 54	reg53, left two bytes of SUBNET MASK address
55 to56	reg55, right two bytes of GATEWAY address
57 to 58	reg57, left two bytes of GATEWAY address
59	reg59, 0, TCP server, (NO USE)
60	reg60, listen port at TCP server mode
61~75	buffer mirror for changing to a new IP address, copy of reg 46 to 60
76	write 1 to set the ghost settings to the system and start new settings, then clear the ghost registers.
93	Enable for MAC setting. It should be set as 1 before write the new MAC to the MAC registers(100-105), and it will be cleared automatically after setting the MAC address.
94~99	Spare
100	pm2.5 value. ug/m3
101	pm10 value. ug/m3
102	AQI
103	AQI LEVEL. 0 = Good,1=Moderate,2=pool for some,3=unhealthy,4=more unhealthy,5=hazardous.
104	the work period. 0 = work all the time. 1~30 minutes.
105	the pm2.5 sensor id
106	Spare

PM2.5 Particle Counter

Address	Register and Description
107	the PM2.5 Sensor Status.0=offline,1=online
108	Spare
109	the main display set. bit0:PM25,bit1:PM10,bit2:AQI,
110	the scroll display set. bit0:sensor status,bit1:rx/tx,bit2:baudrate,bit3:AQI level
111	main display switch time.1~254 seconds
112	the PM2.5 offset
113	the PM10 offset
114	the PM2.5 filter
115	the PM10 filter
116	PM output auto or manual 0: auto 1:manual
117	PM output mode 1:0-10V 2: 0-5V 3:4-20V
118	PM2.5 Min Range
119	PM2.5 Max Range
120	PM10 Min Range
121	PM10 Max Range
:	
:	
126	PM1.0 unit: ug/m3
127	PM2.5
128	PM4.0
129	PM10 unit: ug/m3
130	PM0.5 particle number
131	PM1.0
132	PM2.5
133	PM4.0
134	PM10

PM2.5 Particle Counter

Bacnet Object List

PM2.5 uses Bacnet protocol to communicate with others. Below is the Bacnet object list.

Variable	Variable and Description
0	Spare
1	SerialNumber LowByte
2	SerialNumberHighByte
3	SoftWare Version
4	ID Address
5	Product Model
6	Instance
7	Station number
8	Uart BaudRate.0=9.6kbaud, 1=19.2kbaud 2=38.4kbaud 3=57.6kbaud 4=115.2kbaud
9	Update
10	Protocol. 0=MSTP,3= MODBUS
11~19	Spare
20	OffSet_P25
21	OffSet_P10
22~25	Spare
26	Filter_Pm25
27	Filter_Pm10
28~35	Spare
36	Air Quality Index

Input	Input and Description
0~4	Spare
5	PM2.5
6	PM10

PM2.5 Particle Counter

Mcerts-Certified

The SPS30 particulate matter sensor has achieved MCERTS certification, which proves the performance of the PM sensor. In addition, the certification confirms that the SPS30 can be easily integrated into applications that comply with the European Air Quality Standard DIN EN 15267. The MCERTS certification scheme was established by the UK's Environment Agency and is built around international and European standards to ensure high-quality environmental data monitoring. The SPS30 underwent laboratory and field tests and has been proven to fulfill the latest MCERTS and associated DIN EN 15267 European air quality standards. Compliance with the above-mentioned standards requires low intra-model variability ($\leq 5 \mu\text{g}/\text{m}^3$), making the SPS30 the first choice for integration into applications requiring high precision. The certification is issued by the Sira Certification Service, one of the leading notified in Europe. They are also accredited according to ISO/IEC 17065 UKAS and are part of the Canadian Standards Association (CSA Group).

PM2.5 Particle Counter



Certificate Contents	
Approved Site Application.....	2
Basis of Certification	2
Product Certified.....	2
Certified Performance	3
Description.....	4
General Notes	4.

Approved Site Application

Any potential user should ensure, in consultation with the manufacturer, that the monitoring system is suitable for the intended application. For general guidance on monitoring techniques refer to the Environment Agency Monitoring Technical Guidance Notes available at www.mcerts.net

The indicative dust monitoring analyser(s) can be operated in one of two ways:

For qualitative measurements: Providing qualitative measurement data for the analysis of particulate pollution trends, and source identification studies based for example on pollution roses etc. Such application can rely on instrument factory calibration only.

For quantitative measurements: Providing measurement data with the uncertainty defined for indicative instruments ($\pm 50\%$), as specified by the Air Quality Directive (2008). This can be achieved on condition that each instrument used for measurement has been calibrated on the specific site where monitoring is taking place against a standard reference method for a period of two weeks and the resulting slope and intercept have been used for instrument calibration. Using non-standard filters and procedures for this purpose is not acceptable. To maintain the validity of data this calibration has to be repeated at least every twelve months or when the instrument is moved to a different site. Consistent results of the calibration may lead to less frequent repetition of the calibration process, in agreement with a competent authority, such as the Environment Agency or other Environmental regulator.

They cannot be used as a substitute for continuous ambient air quality monitoring systems (CAMs) employed in national air quality monitoring networks for the EU Air Quality Directive

Basis of Certification

This certification is based on the following Test Report(s) and on Sira's assessment and ongoing surveillance of the product and the manufacturing process:

MCERTS Report 80010867 dated 25/11/2019

Product Certified

The measuring system consists of the following parts:

- SPS30 Particulate Matter Sensor

This certificate applies to all instruments fitted with firmware version 1.0 and manufactured date 28/11/2019 onwards.

Certificate No : Sira MC200350/00

This Certificate issued : 08 January 2020

This certificate may only be reproduced in its entirety and without change
To authenticate the validity of this certificate please visit www.csagroupuk.org/mcerts

PM2.5 Particle Counter



Certified Performance

Test	Result	MCERTS specification
Consistency of the sample volumetric flow	Pass	Remain constant within $\pm 3\%$ of rated value
Tightness of the sampling system	Pass	Leakage not to exceed 2% of sampled volume
Intra-instrument uncertainty for the reference method	1.73 $\mu\text{g}/\text{m}^3$	$\leq 5\mu\text{g}/\text{m}^3$
Intra-instrument uncertainty for the candidate method All data (125) $\geq 18 \mu\text{g}/\text{m}^3$ $\leq 18 \mu\text{g}/\text{m}^3$	0.22 $\mu\text{g}/\text{m}^3$ 0.54 $\mu\text{g}/\text{m}^3$ 0.15 $\mu\text{g}/\text{m}^3$	$\leq 5\mu\text{g}/\text{m}^3$
Highest resulting uncertainty estimate comparison against data quality objective (Measurement Uncertainty)	8.9%	$\text{WCM} \leq \text{Wd}_{\text{qo}}$ Measured uncertainty defined as 50% for indicative instruments
Maintenance Interval	>Two weeks Note 1	>Two weeks

Note 1: No maintenance was required over the 4 month field trial in an urban location

Certificate No : Sira MC200350/00
This Certificate issued : 08 January 2020

This certificate may only be reproduced in its entirety and without change
To authenticate the validity of this certificate please visit www.csagroupuk.org/mcerts

PM2.5 Particle Counter



Description

The SPS30 Particulate Matter Sensor uses a focused laser beam to illuminate the incoming sample air, which is controlled by a fan. The light scattered by particles in the air stream is collected on a photodiode that converts the light intensity into an electrical signal. Using proprietary algorithms, the SPS30 Particulate Matter Sensor converts the electrical signal into various mass and number concentration outputs, even with a small sample airflow (due to the miniaturized design) and a short measurement time. The monitoring system uses unique contamination resistance technology to keep the optics clean and maintenance-free throughout its lifetime.

General Notes

1. This certificate is based upon the equipment tested. The Manufacturer is responsible for ensuring that on-going production complies with the standard(s) and performance criteria defined in this Certificate. The Manufacturer is required to maintain an approved quality management system controlling the manufacture of the certified product. Both the product and the quality management system shall be subject to regular surveillance according to 'Regulations Applicable to the Holders of Sira Certificates'.
2. The design of the product certified is defined in the Sira Design Schedule V00 for certificate No. Sira MC20350/00
3. If certified product is found not to comply, Sira Certification Service should be notified immediately at the address shown on this certificate.
3. The Certification Marks that can be applied to the product or used in publicity material are defined in 'Regulations Applicable to the Holders of Sira Certificates'.
4. This document remains the property of Sira and shall be returned when requested by the company.

Certificate No : Sira MC200350/00

This Certificate issued : 08 January 2020

This certificate may only be reproduced in its entirety and without change
To authenticate the validity of this certificate please visit www.csagroupuk.org/mcerts